

C.S. OF TIE BEAM
SIZE - 0.23M X 0.30M

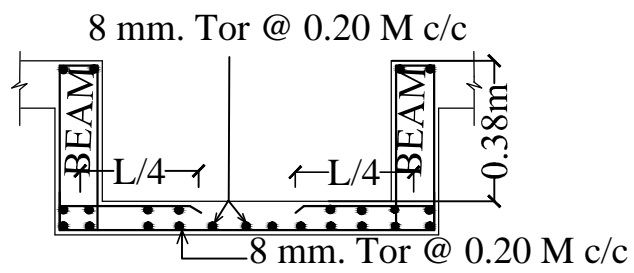

THICKNESS OF SLAB = 0.11m

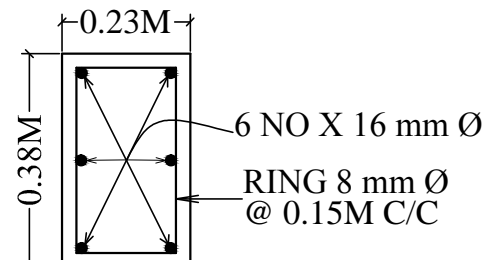

C.S. OF COLUMN .
SIZE - 0.23M X 0.38M

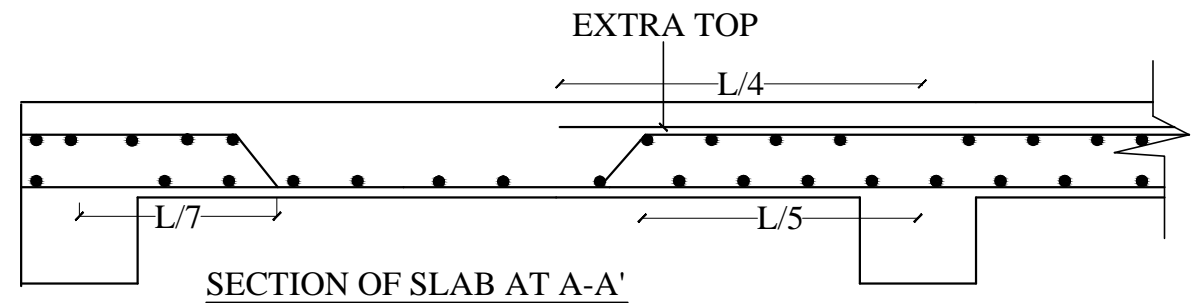

SECTION OF SLAB AT A-A'

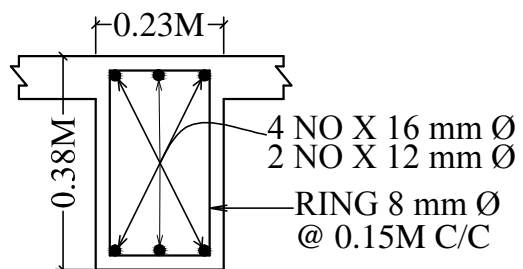

C.S. OF ROOF BEAM
SIZE - 0.23M X 0.38M

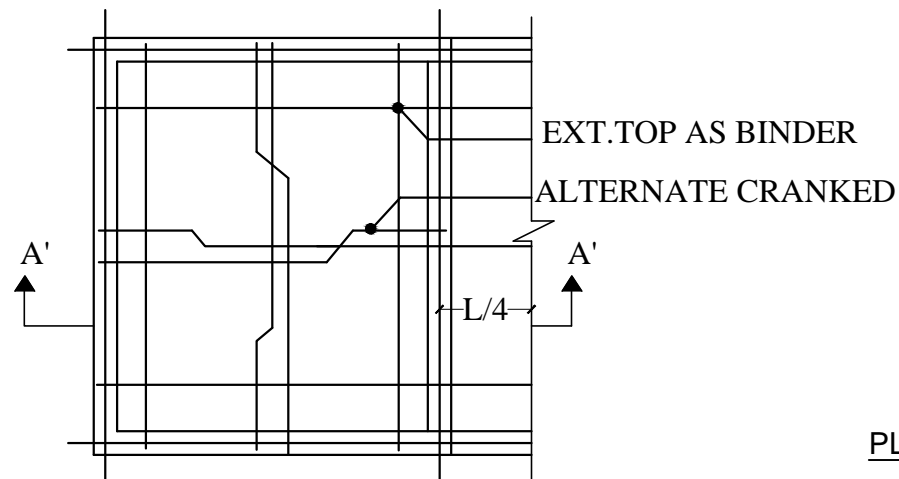

TYPICAL

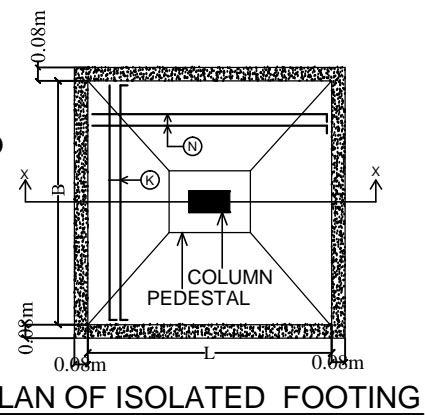

PLAN OF ISOLATED FOOTING

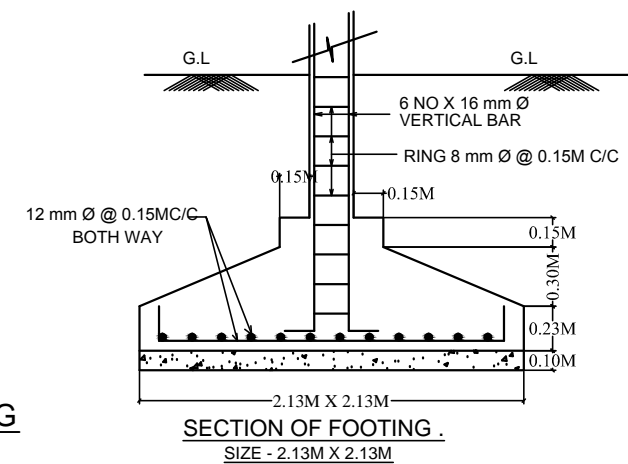

SECTION OF FOOTING .
SIZE - 2.13M X 2.13M

Structure Detail