

DETAILS OF WATER HARVESTING

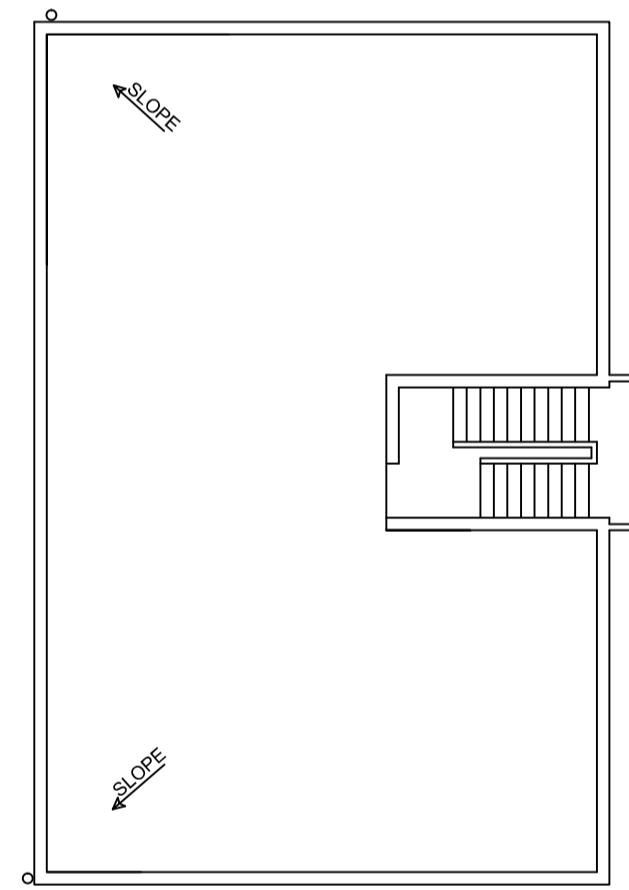

TERRACE FLOOR PLAN

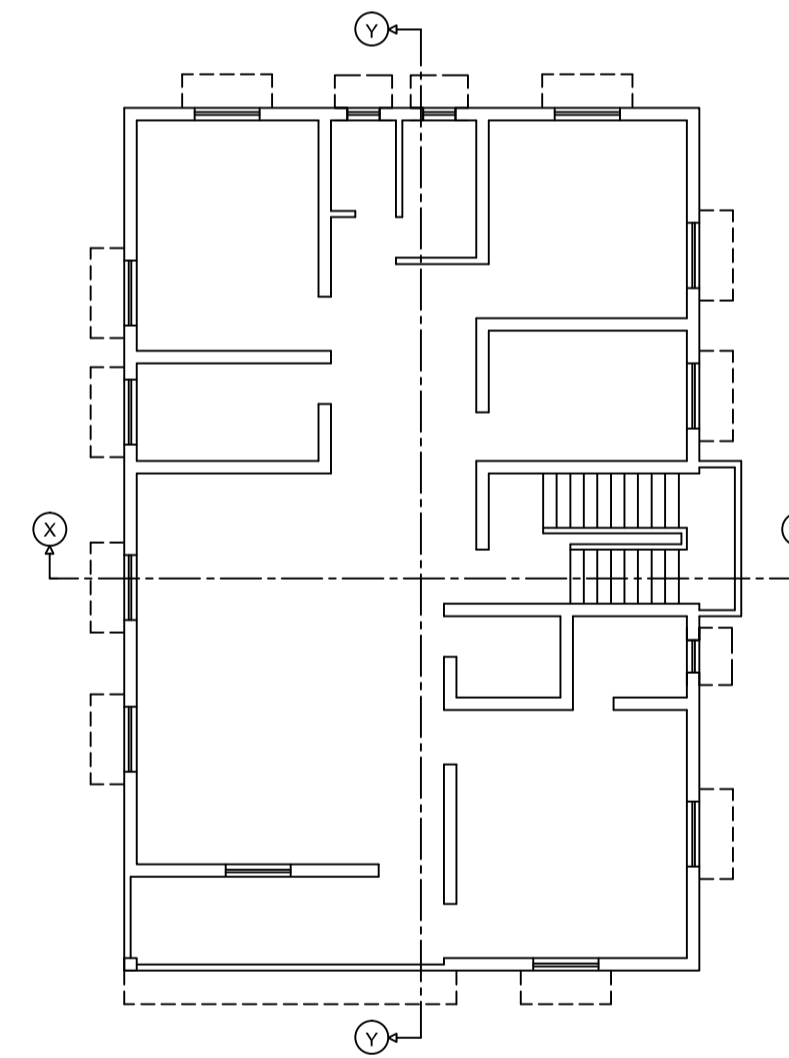
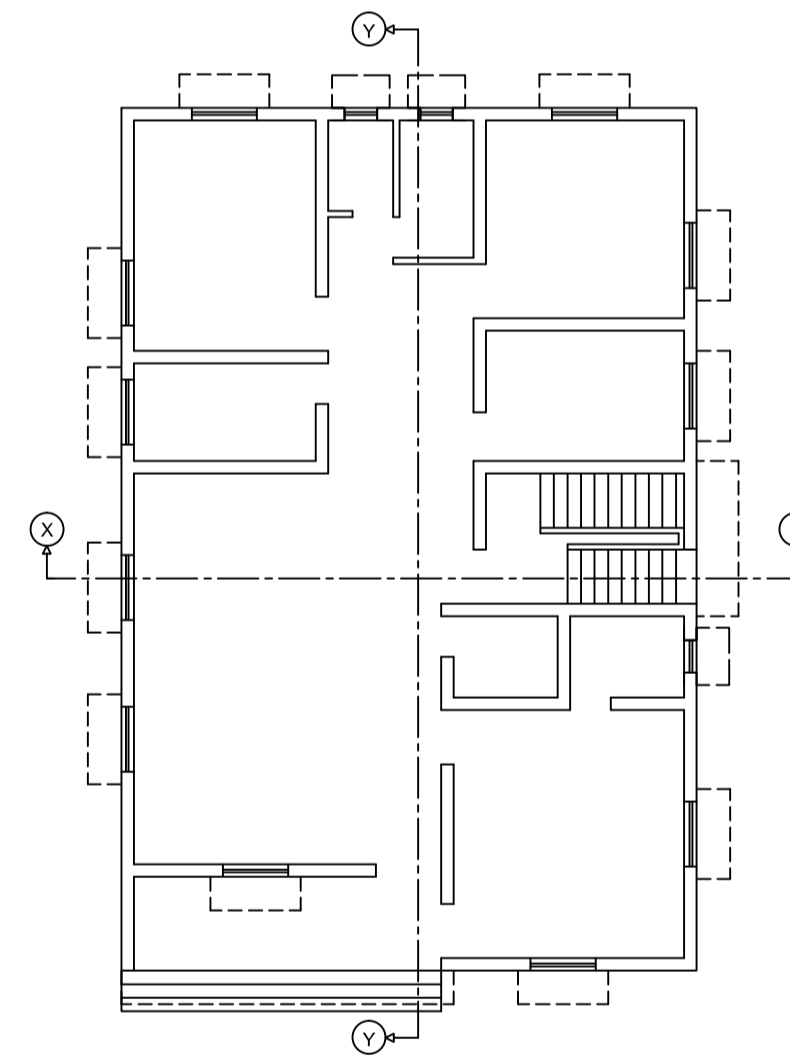
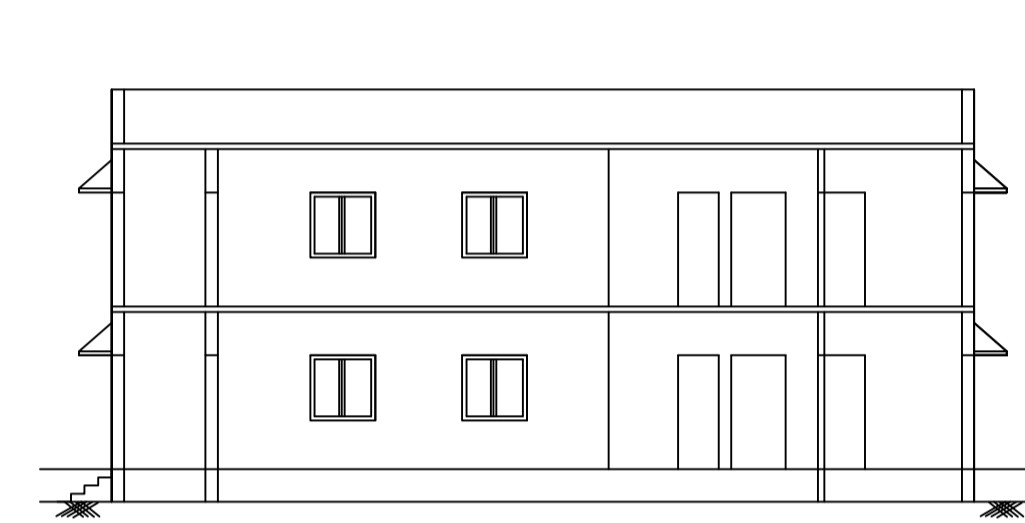
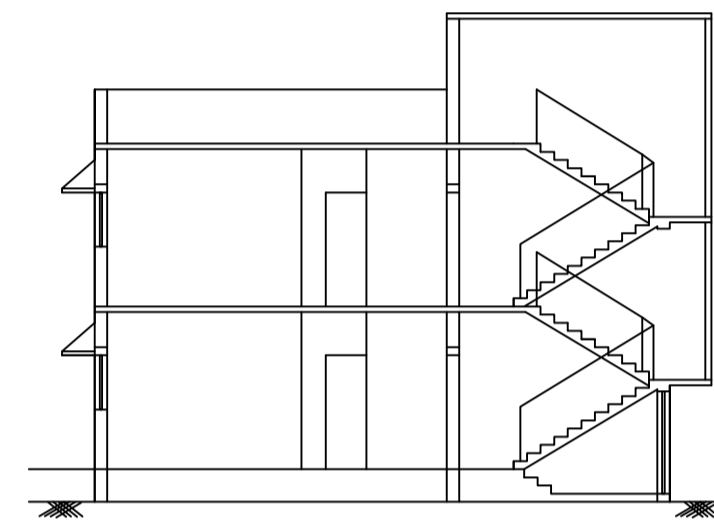
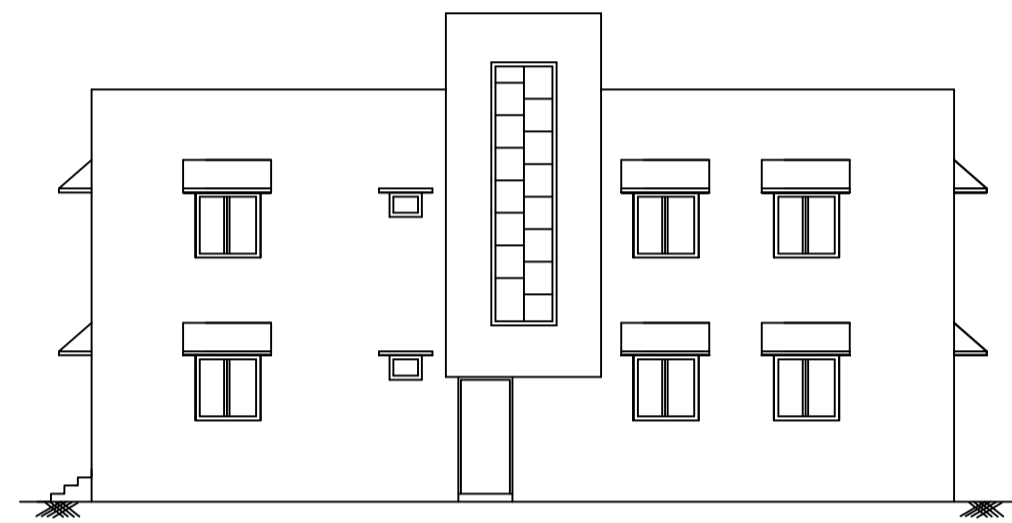
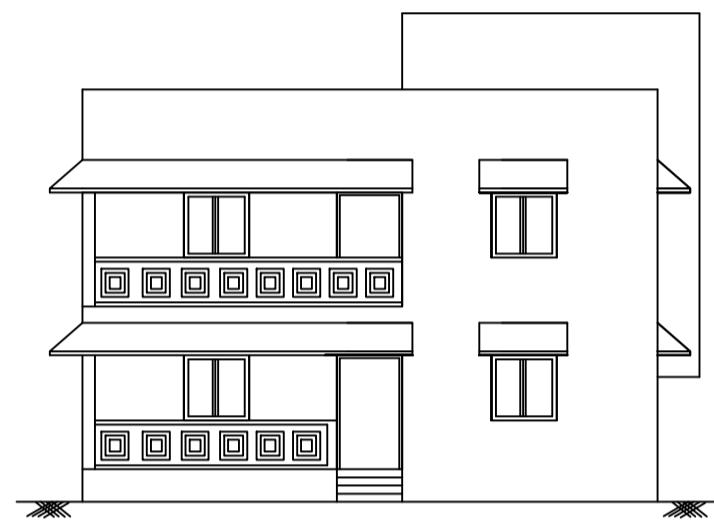
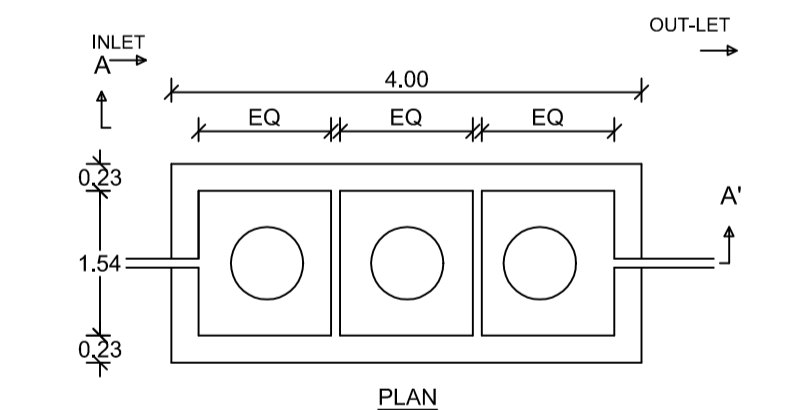
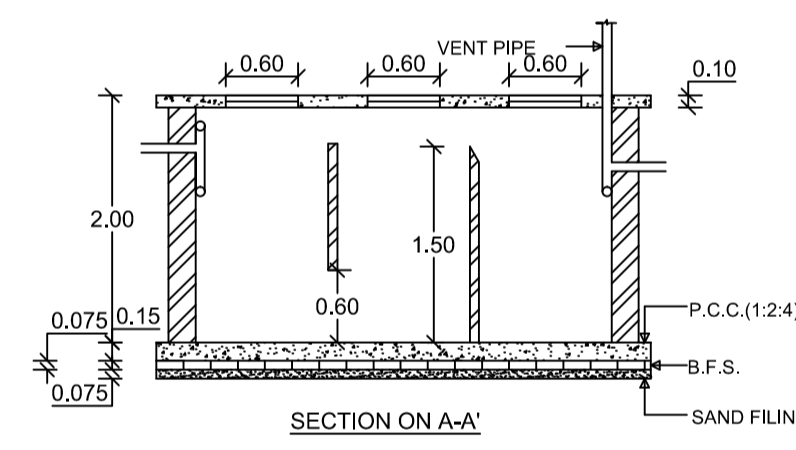

DETAILS OF SEPTIC TANK

