

**SECTION - XX**  
scale - 1:100

**SECTION - YY**  
scale - 1:100

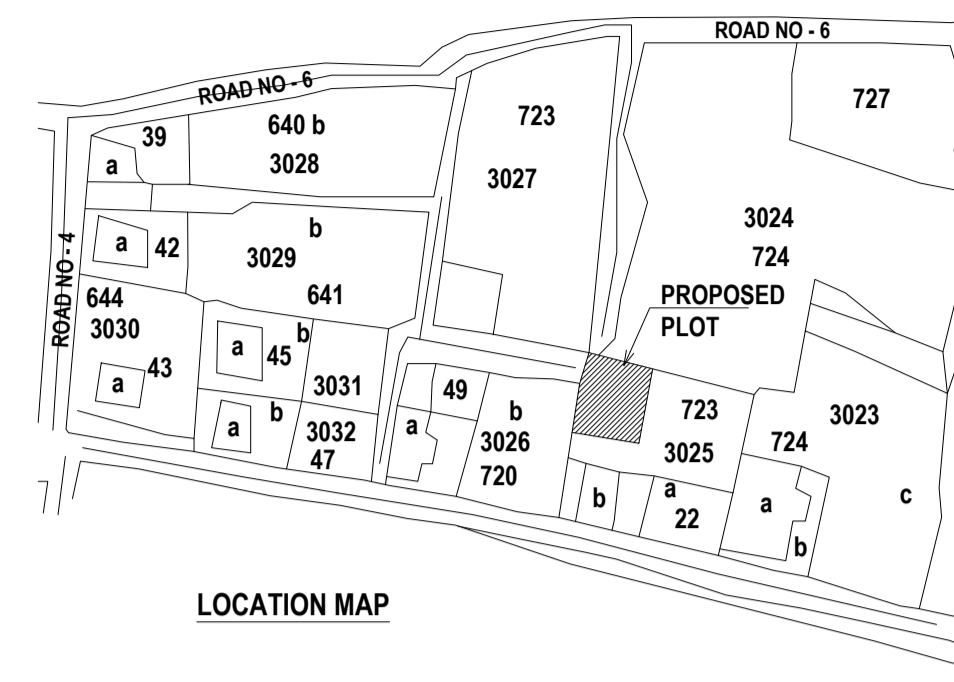

**LOCATION MAP**

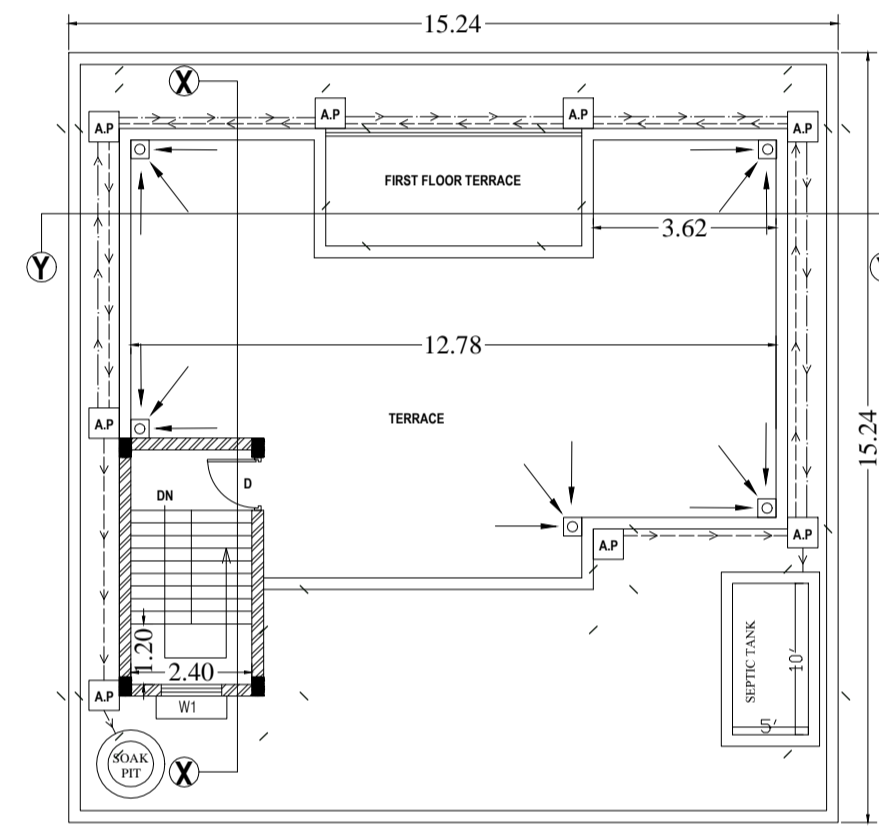

**TERRACE FLOOR PLAN**  
scale - 1:100

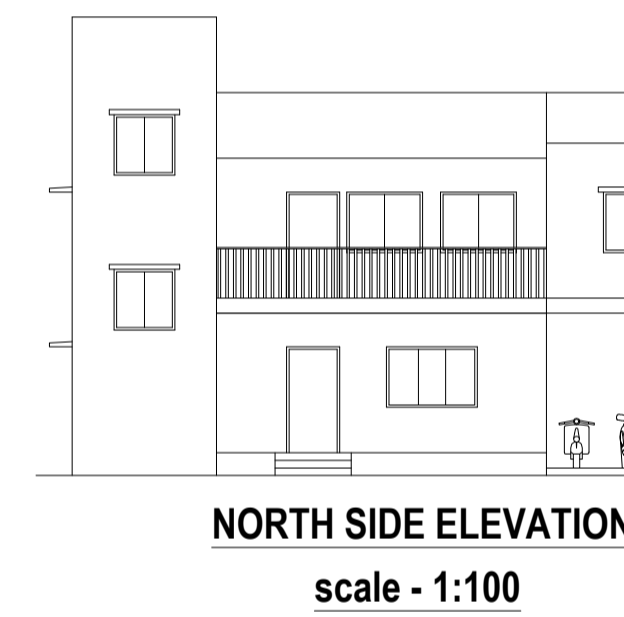
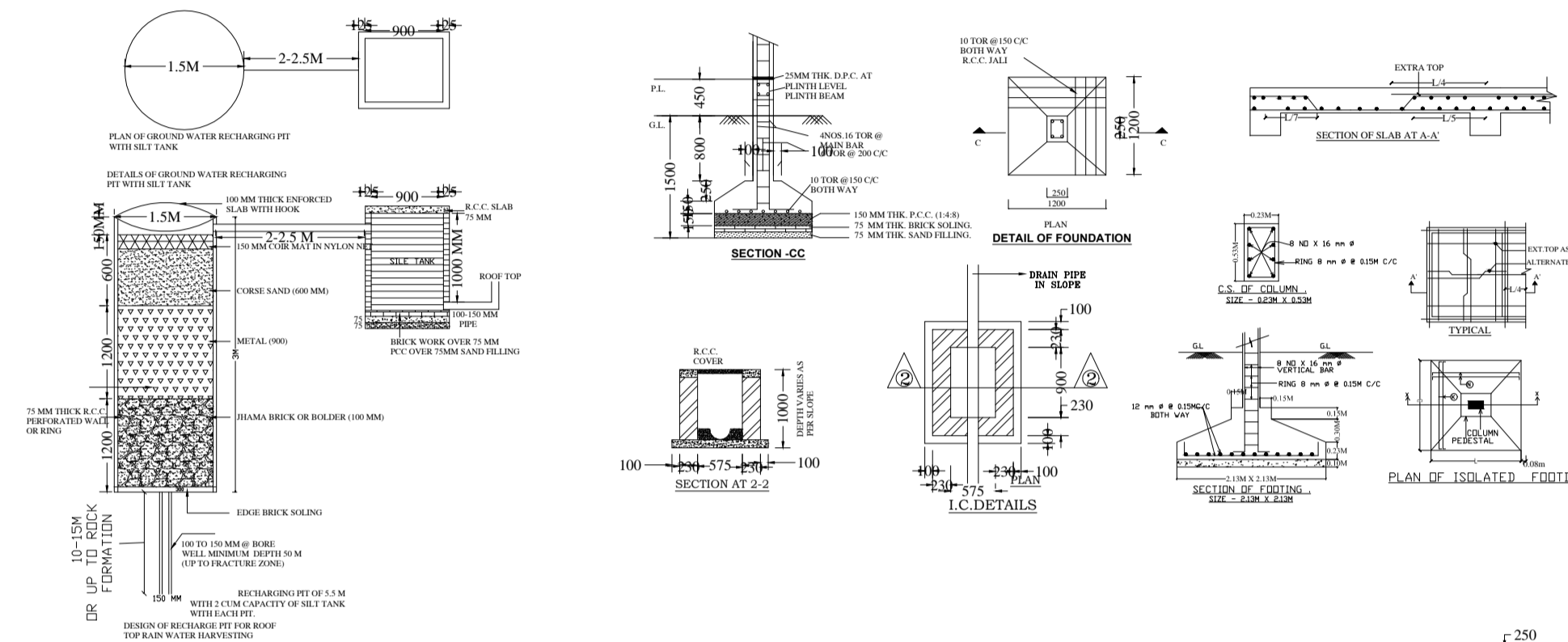

**NORTH SIDE ELEVATION**  
scale - 1:100

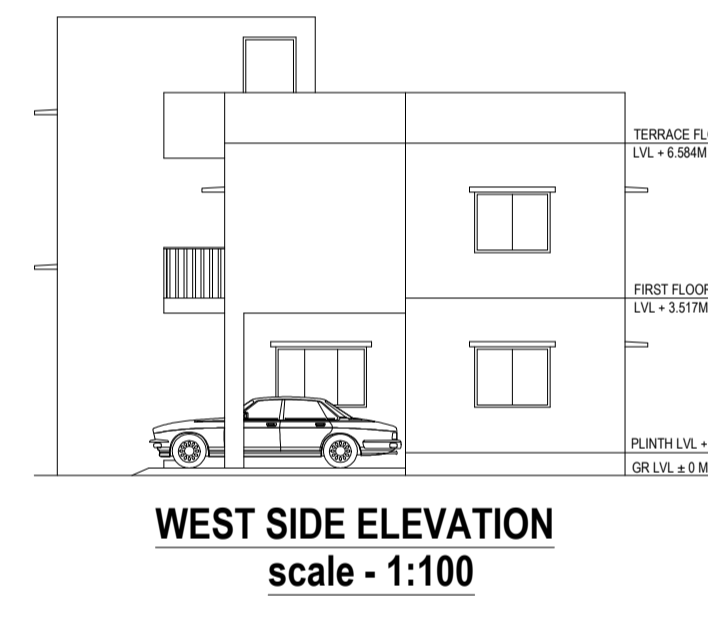

**WEST SIDE ELEVATION**  
scale - 1:100

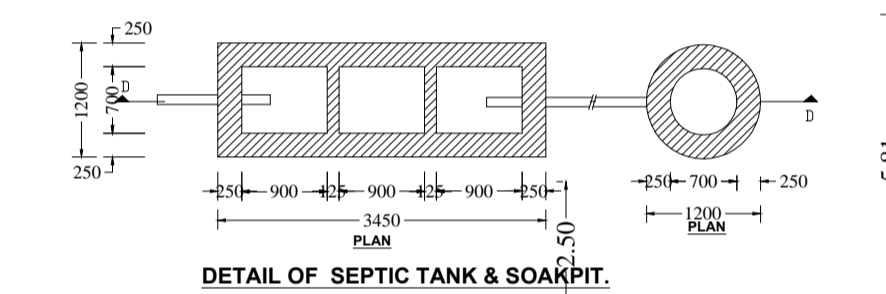

**DETAIL OF SEPTIC TANK & SOAKPIT**

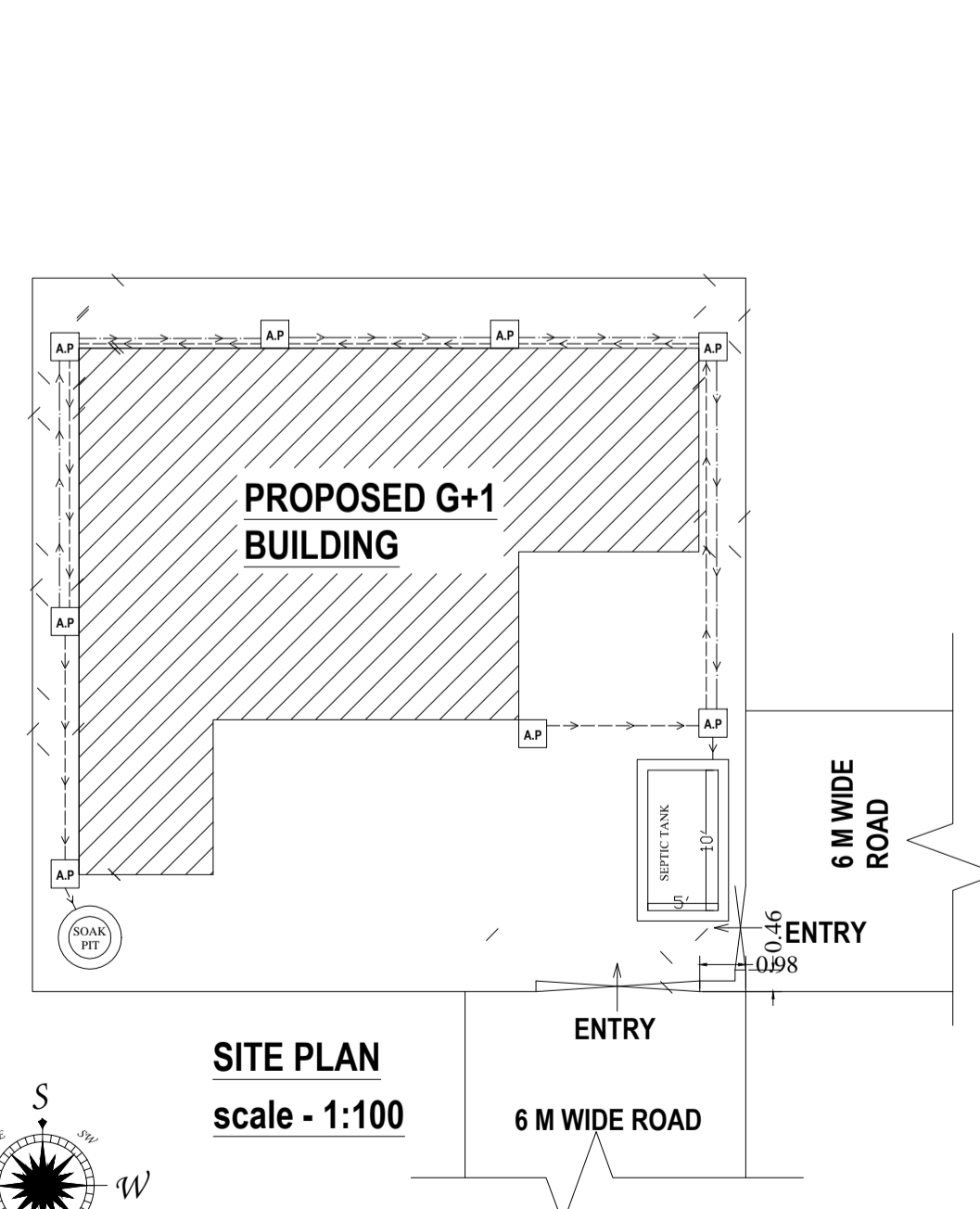
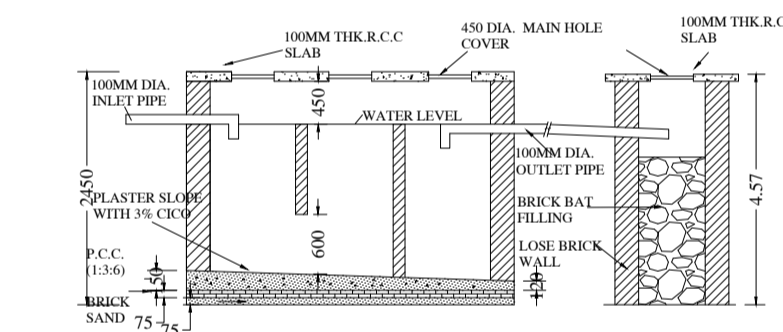

**SITE PLAN**  
scale - 1:100

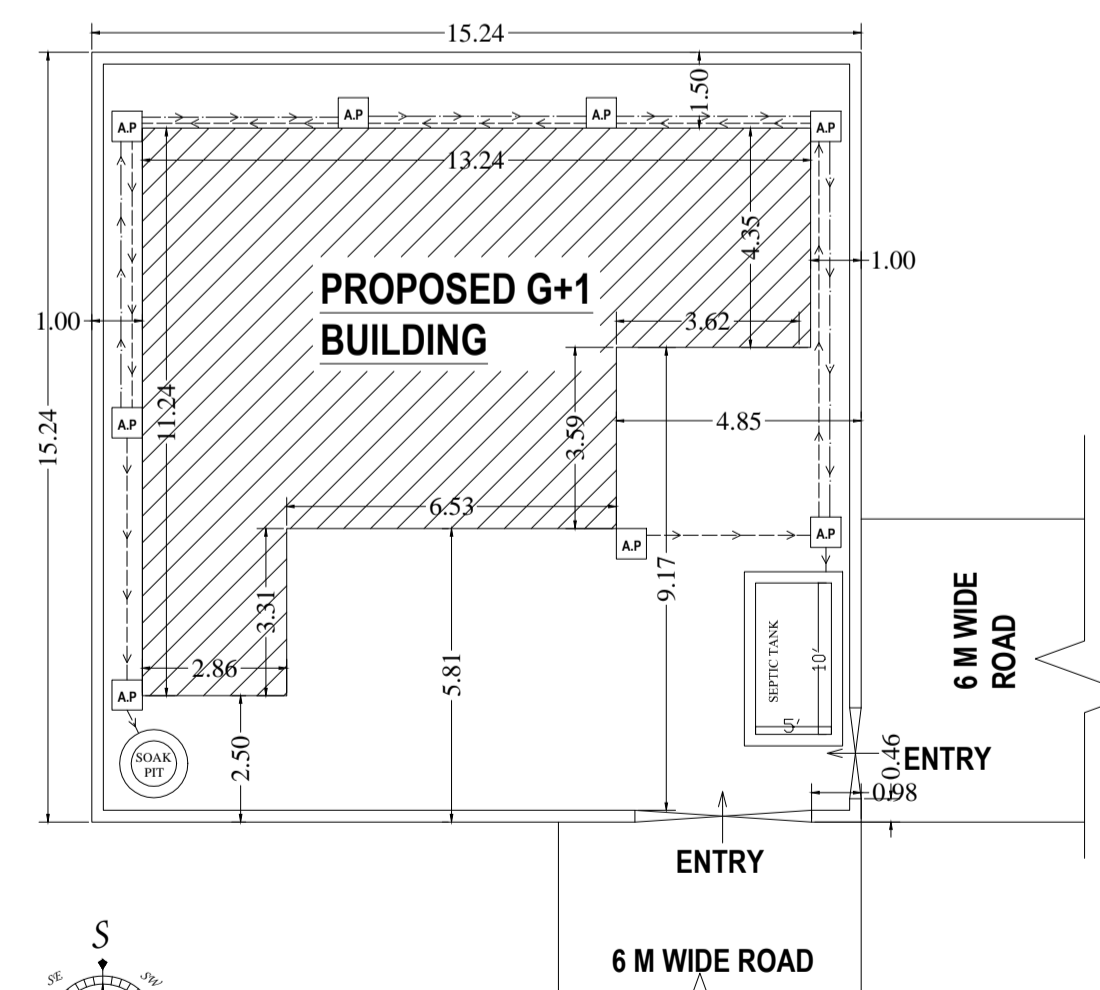

**SITE PLAN**  
scale - 1:100

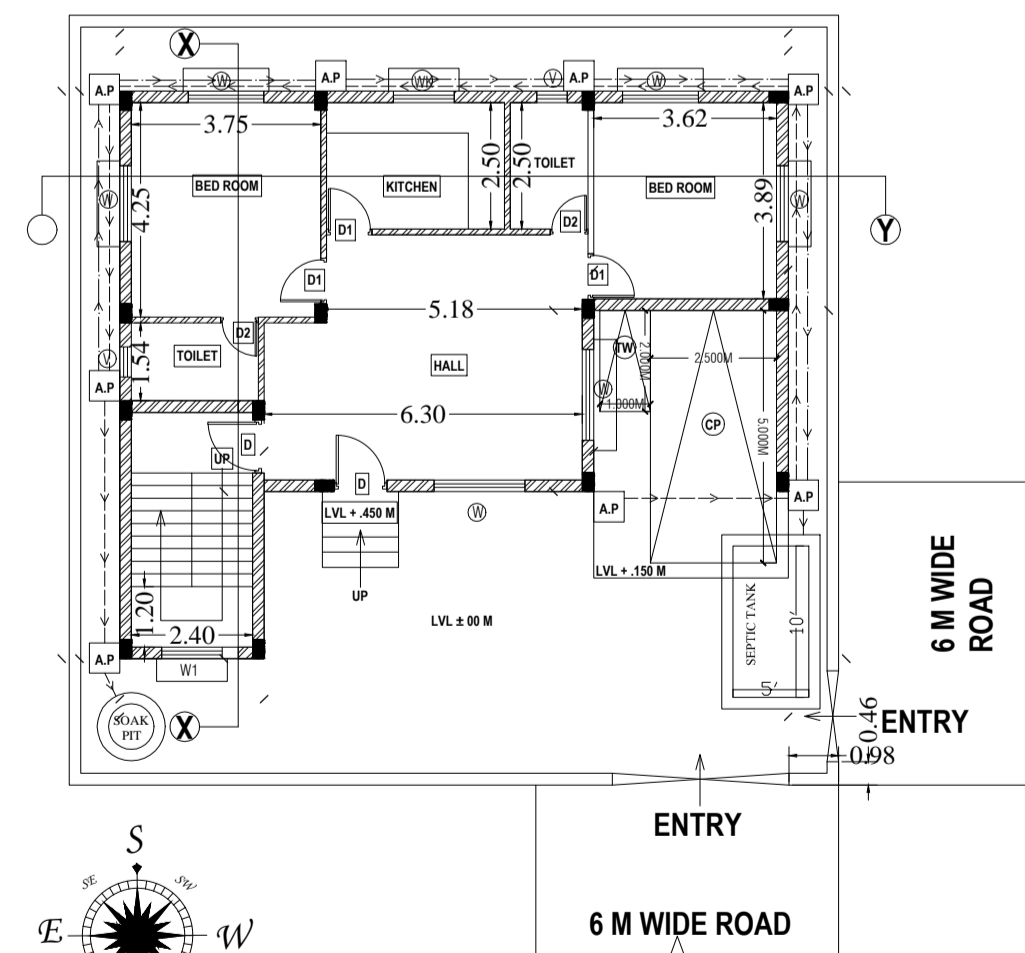

**GROUND FLOOR PLAN**  
scale - 1:100

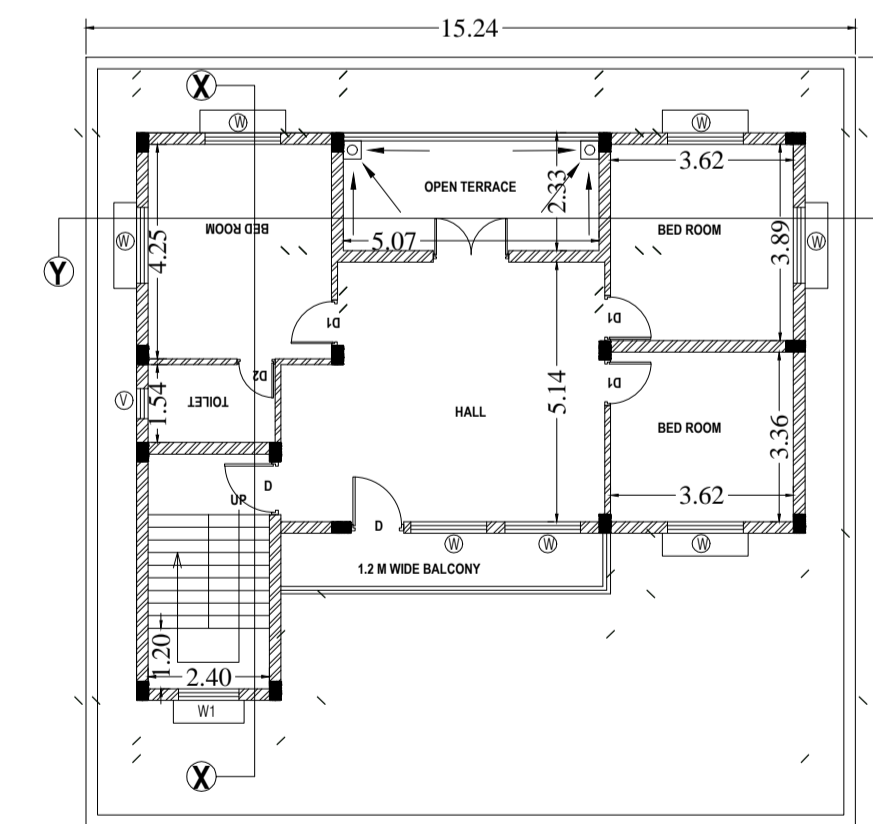

**FIRST FLOOR PLAN**  
scale - 1:100

