

SECTION OF TYPICAL FLOOR BEAM

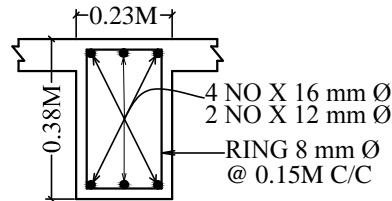

C.S. OF ROOF BEAM
SIZE - 0.23M X 0.38M

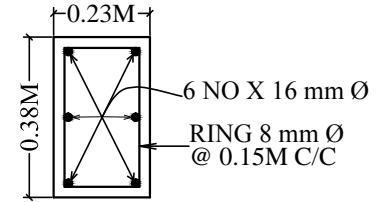

C.S. OF COLUMN
SIZE - 0.23M X 0.38M

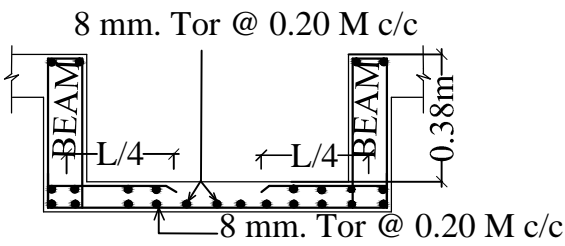

THICKNESS OF SLAB = 0.11m

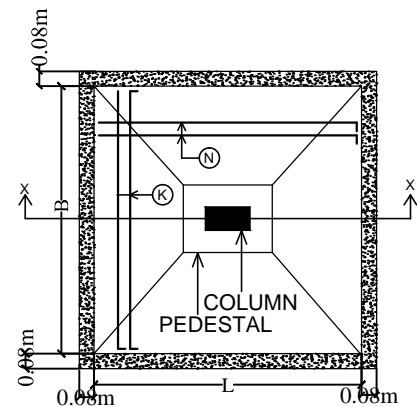

PLAN OF ISOLATED FOOTING

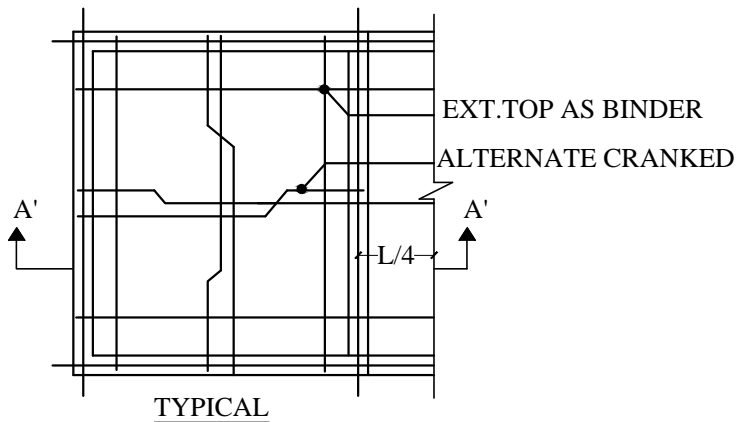

TYPICAL

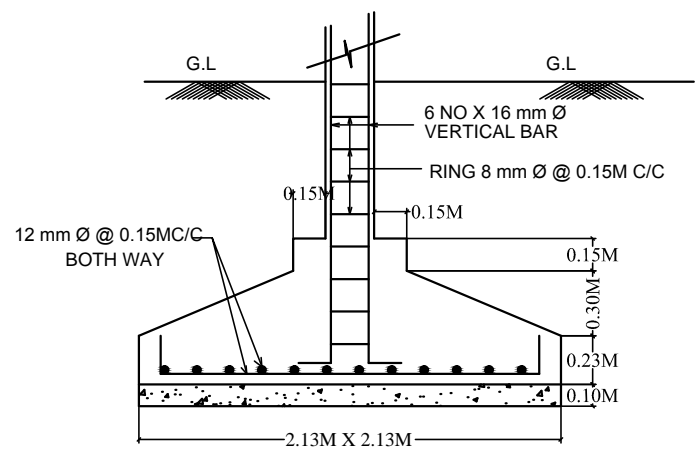

SECTION OF FOOTING
SIZE - 2.13M X 2.13M

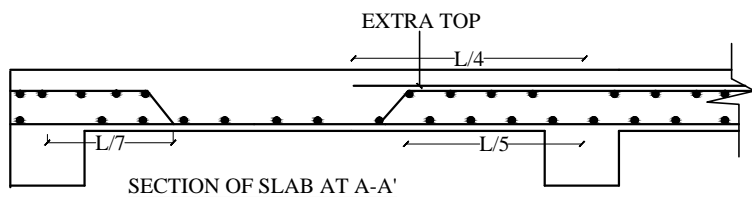

SECTION OF SLAB AT A-A'

Structure Detail