

FRONT ELEVATION

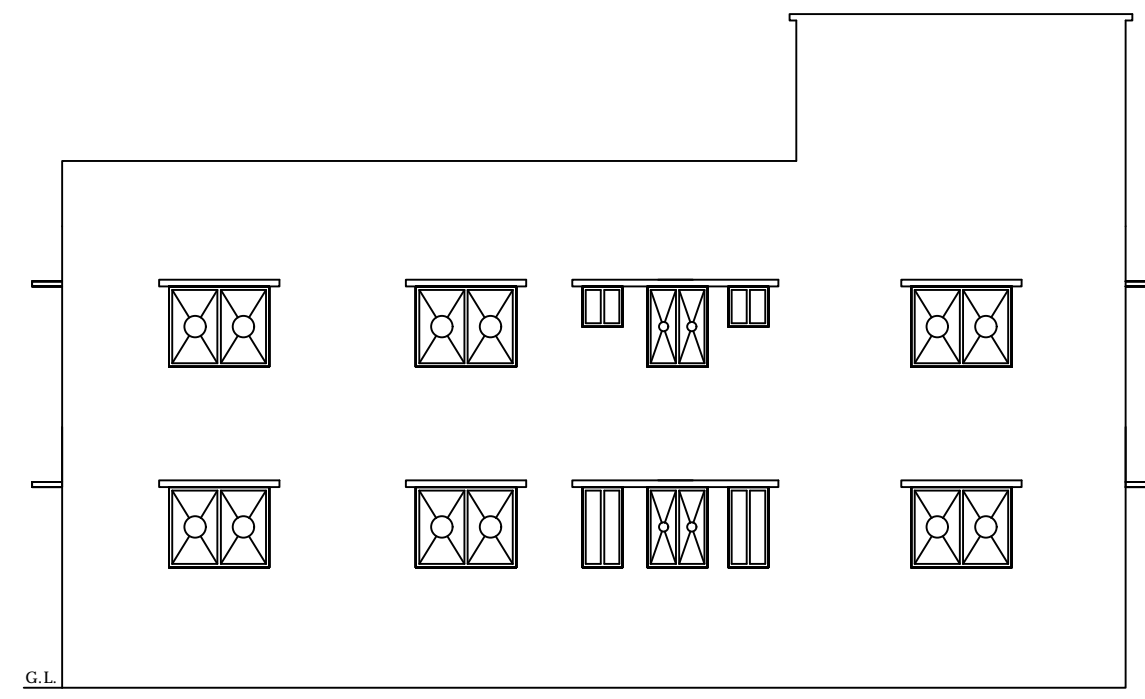

SOUTH SIDE ELEVATION

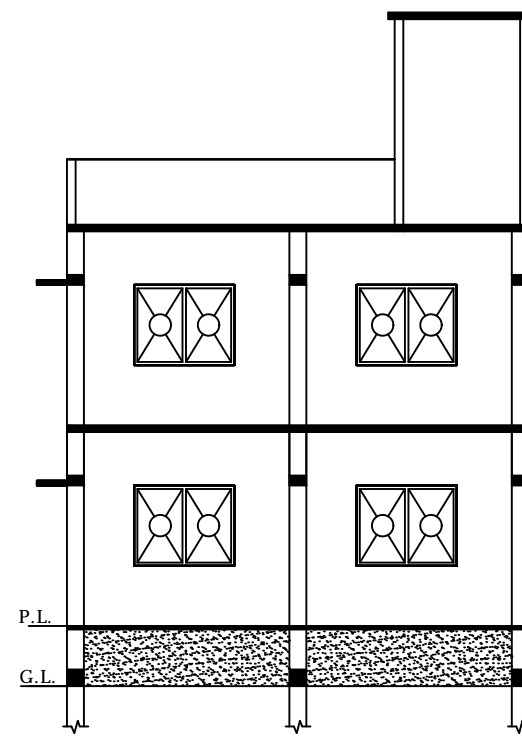

SECTION-YY

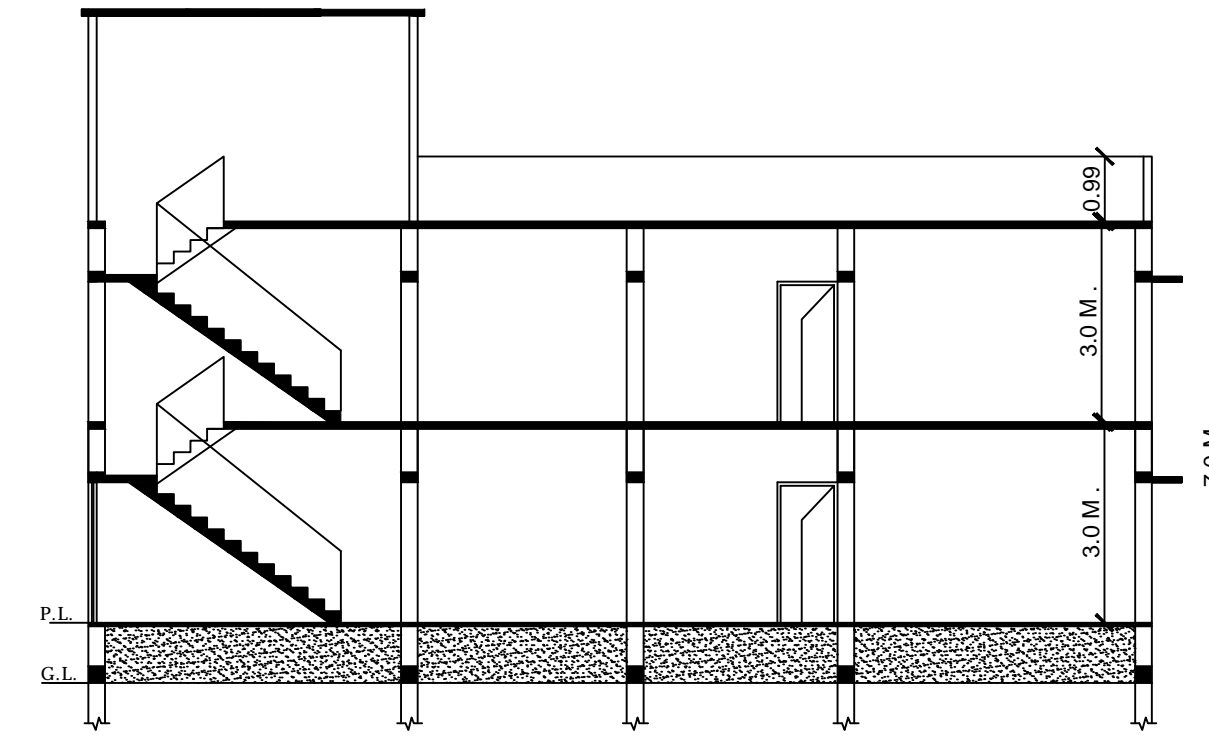

SECTION-XX

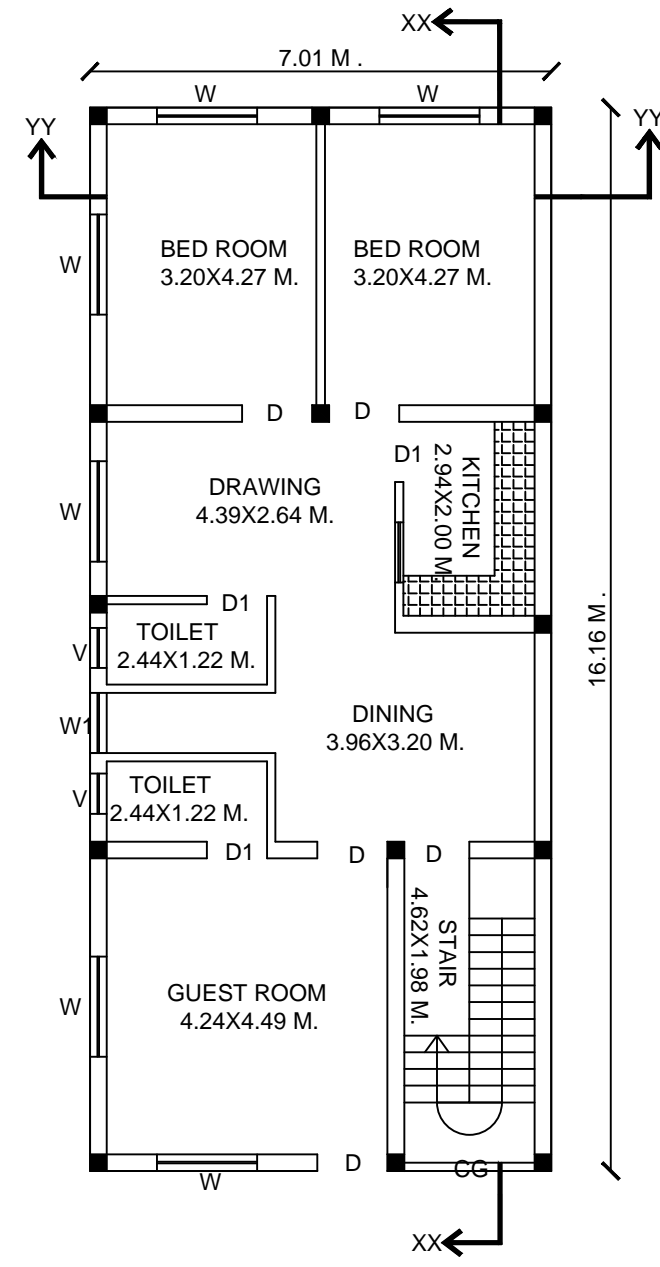

PROPOSED GROUND FLOOR PLAN

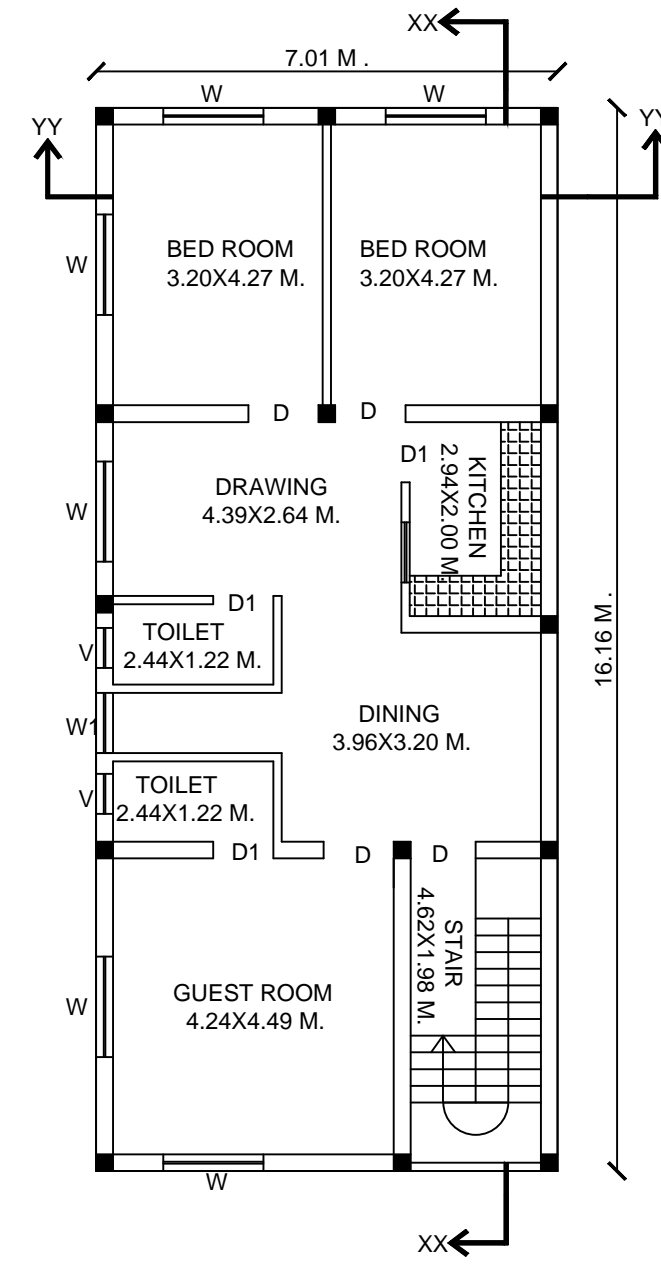

PROPOSED FIRST FLOOR PLAN

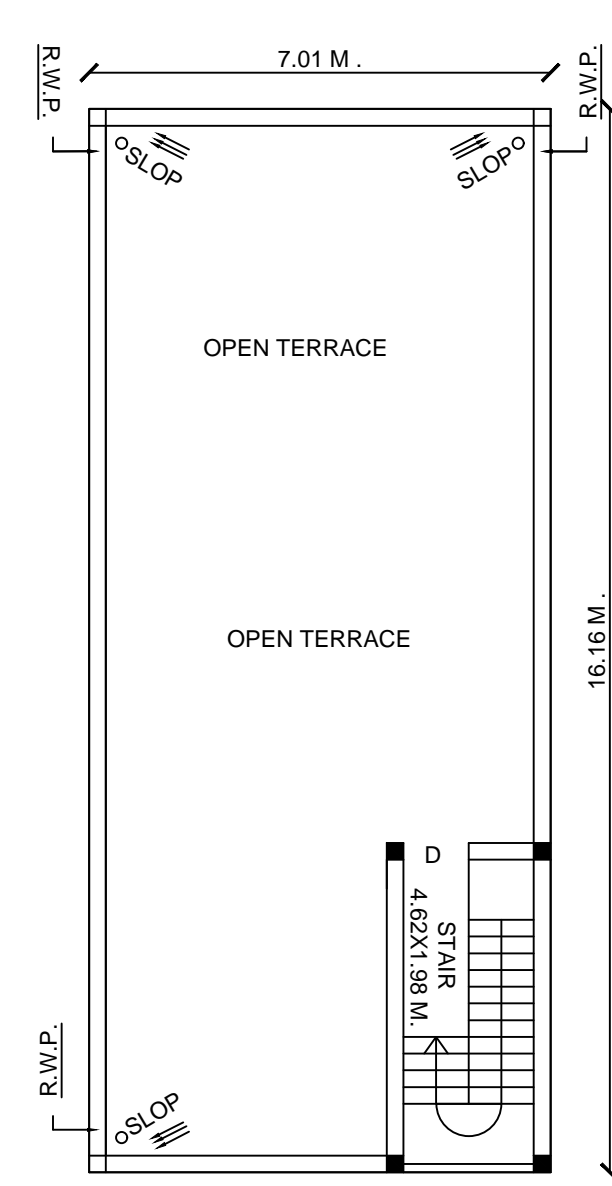

TERRACE FLOOR PLAN

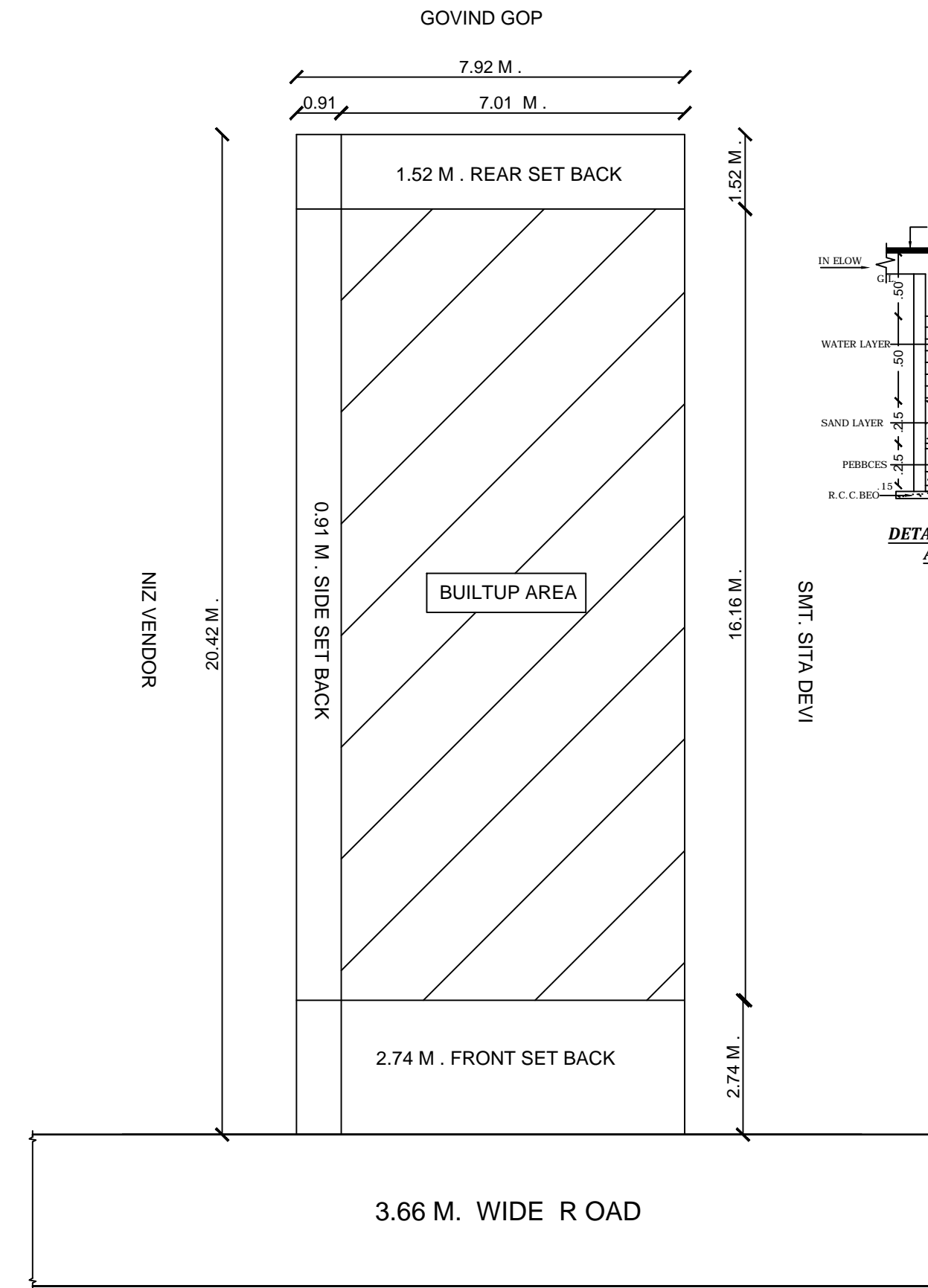

SITE PLAN

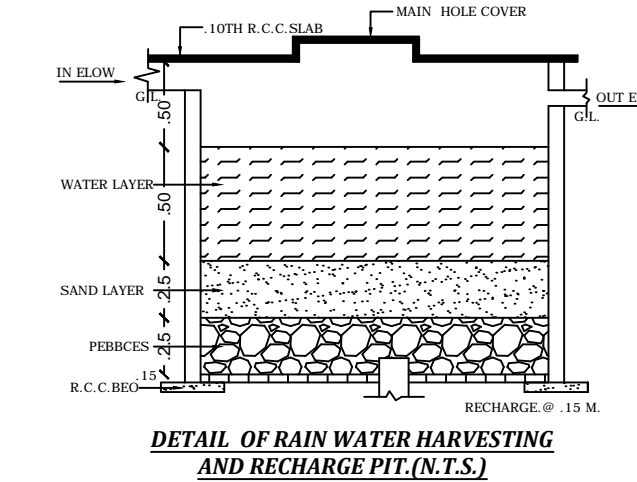

DETAIL OF RAIN WATER HARVESTING AND RECHARGE PIT (N.T.S.)

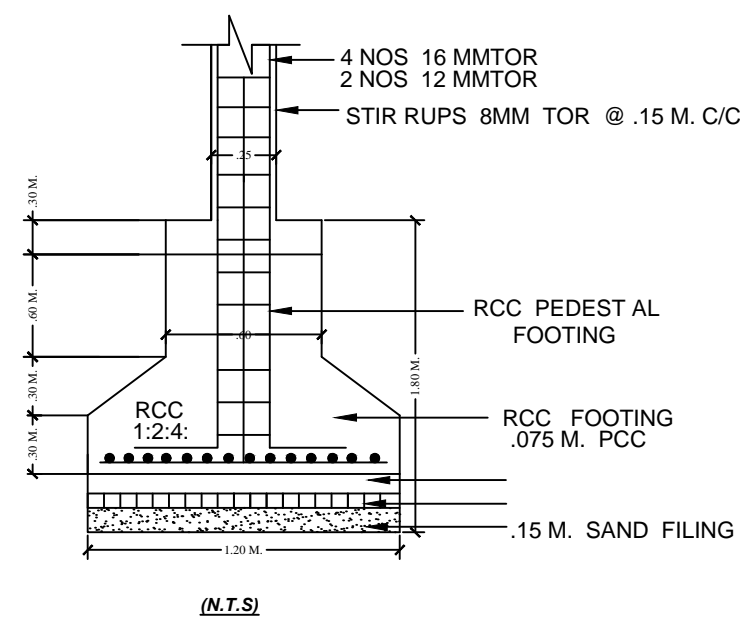

(N.T.S)

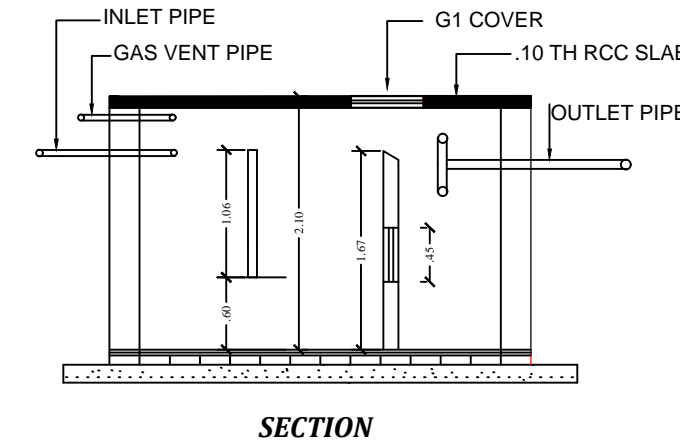

SECTION

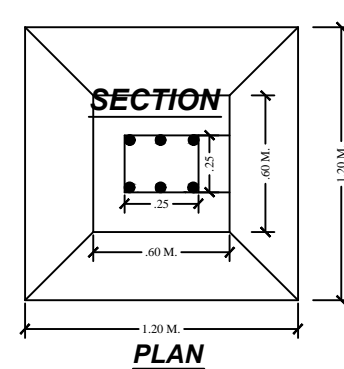

PLAN

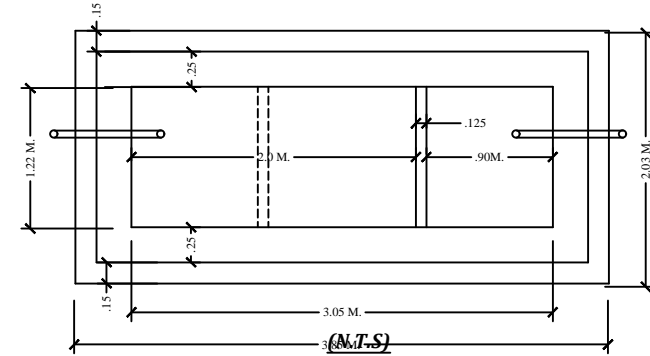

PLAN

DETAIL OF SEPTIC TANK

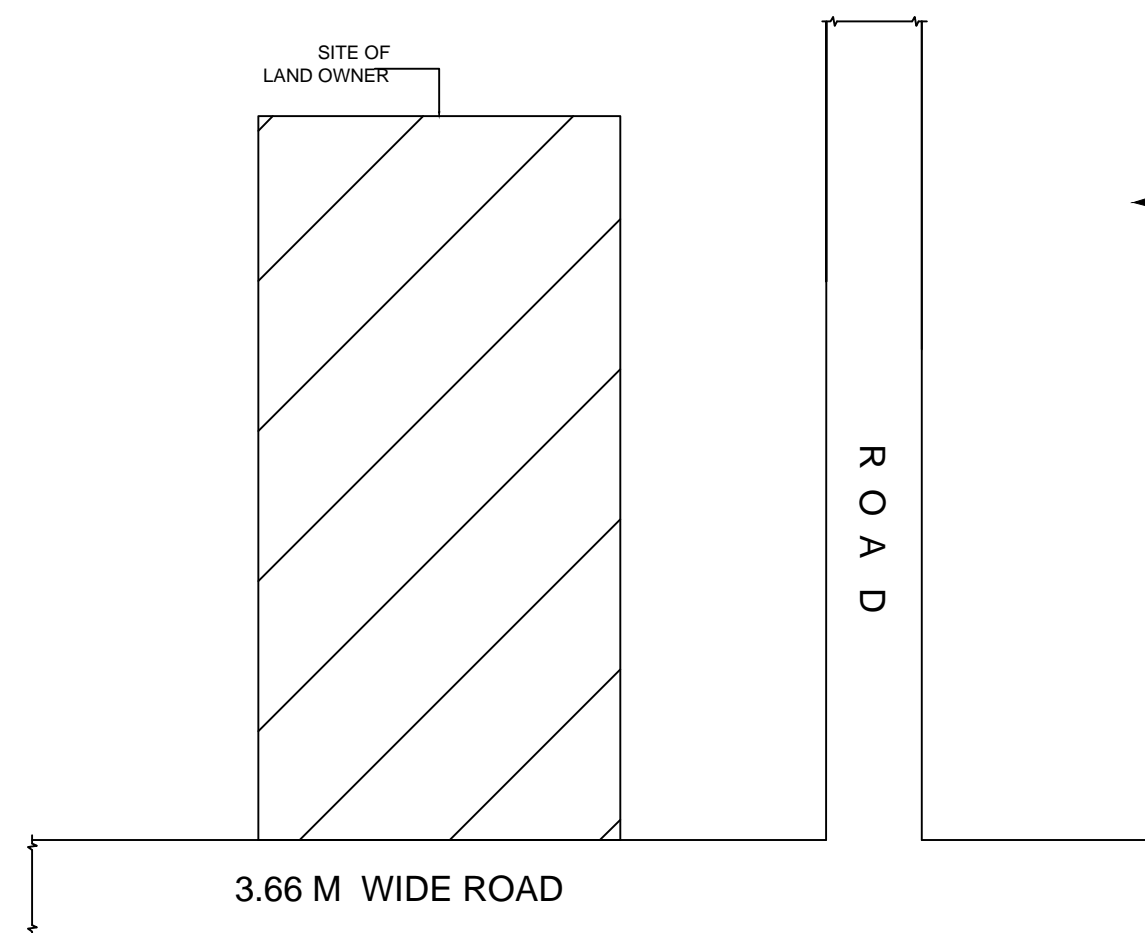

LOCATION PLAN

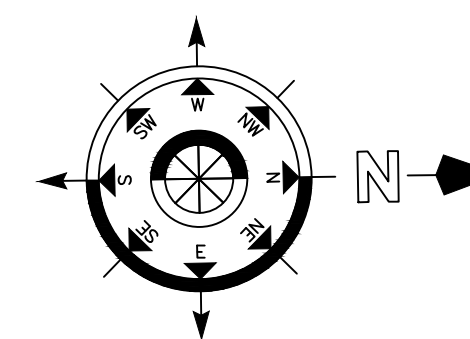

**SCHEDULE OF DS & WS**

TYPE	SIZE	REMARKS
D	1.06 M.X2.10 M.	F PANELED
D1	0.06 M.X2.10 M.	F PANELED
D2	0.75 M.X2.10 M.	F PANELED
W	1.50 M.X1.20 M.	F GLAZZED
W1	1.20 M.X1.20 M.	F GLAZZED
W2	0.91 M.X1.20 M.	F GLAZZED
C.GATE	2.10 M.X2.10 M.	IRON

**SPECIFICATION**

- DETAIL OF R.C.C. FOOTING COLUMN FON ( M.25 )
- 1ST CLASS BRICK WORK IN CEMENT PLASTER ( 1:6 )
- 1.25X.15TH. R.C.C. LINTEL BAND OVER DOOR'S & WINDOW'S
- .10TH. LIME CON. TERR.OVER .10TH. R.C.C. ROOF SLAB(M.25)
- SAL WOOD FRAME & SUAM WOOD SHUTTER.
- 0.012TH. IN CEMENT PLASTER IN BOTH SIDE WACC ( 1:6 )
- MARBLE OR MOSAIC FLOORING OVER .110TH. DRY RAMMED KHOA OVER B.F. SOILING , OVER LOCAL SAND FILLING .
- 2 CUAT OF WHITE & COLOUR WASH AS PER CHOICE.
- 17CM.WIDE & 30 CM. PUCCA DRAIN AROUND THE BUILDING .

TOTAL PLOT AREA	=	161.72	SQM.
NET PLOT AREA	=	161.72	SQM .
TOTAL OPEN LAND AREA	=	48.44	SQM.
GROUND FLOOR B/A	=	113.28	SQM .
FIRST FLOOR B/A	=	113.28	SQM .
TOTAL	=	226.56	SQM .
F.A.R.	=	1.40	
% OF COVRED AREA	=	70 %	
BUILDING HEIGHT	=	7.0 M.	

PROPOSED RESIDENTIAL BUILDING OF  
 NAME- SMT.NIRMALA DEVI  
 W/O - SRI ASHOK DANGI  
 MAUZA NAGWAN  
 P.S. - CHATRA  
 P.S. NO.- 182  
 WARD NO. - 11  
 KHATA NO.- 114  
 H. NO. -  
 PLOT NO.- 578  
 TOUZI NO.- 28  
 DIST. - CHATRA (JHARKHAND)

MAP APPROVED BY

SIGNATURE OF APPLICANT

SIGNATURE OF ENGINEER