

77 DT 6-9-21

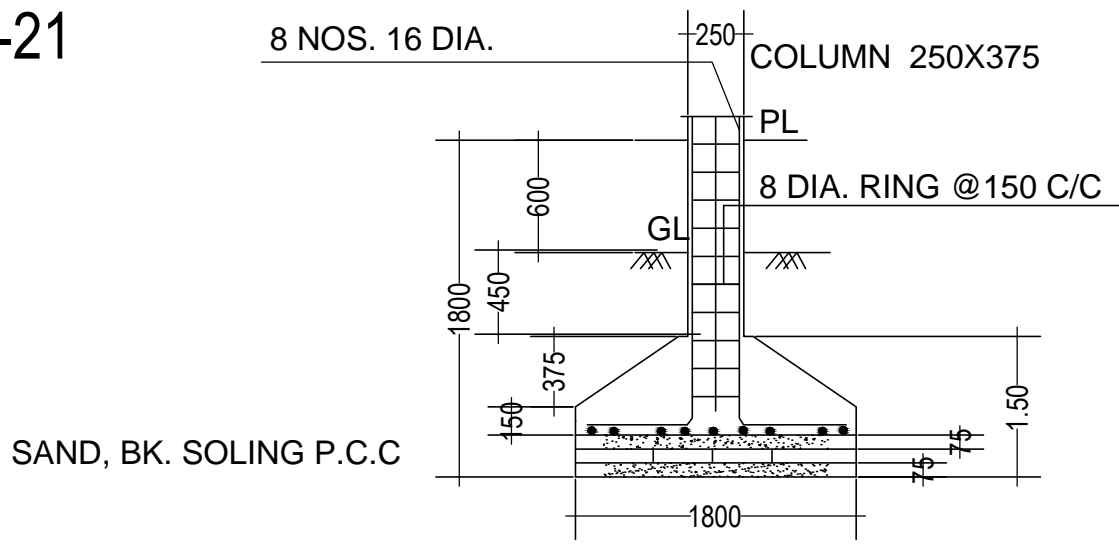

SECTION ON C-C

SCALE - 1 : 50

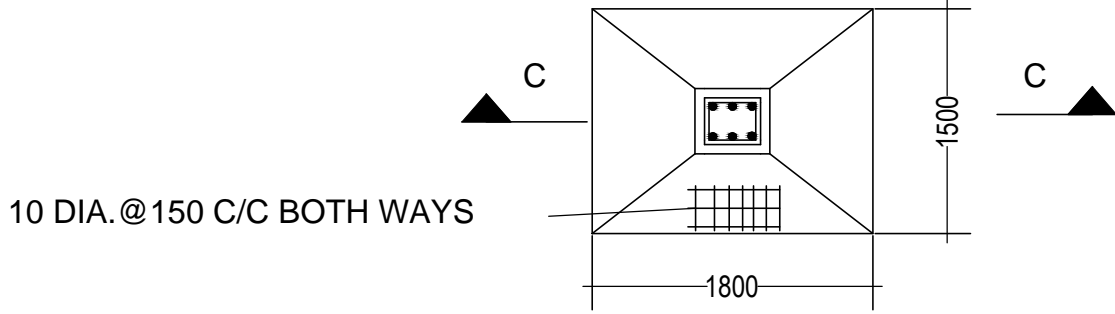

DETAIL OF R.C.C. COLUMN

SCALE - 1 : 50