

Project Title :SRI IGNATIUS TIRKEY

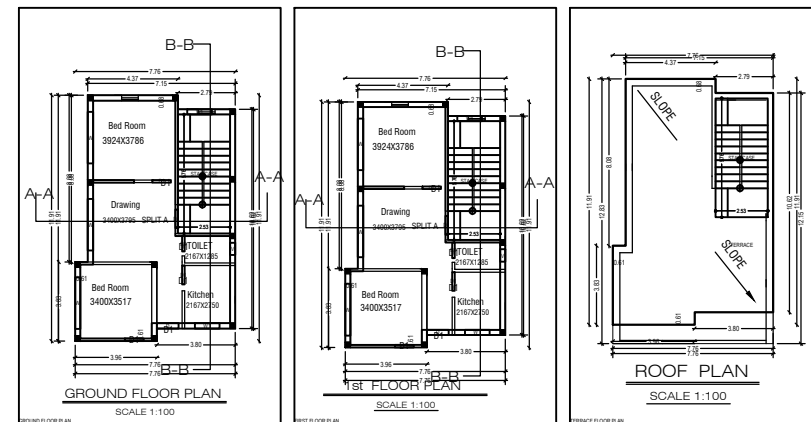
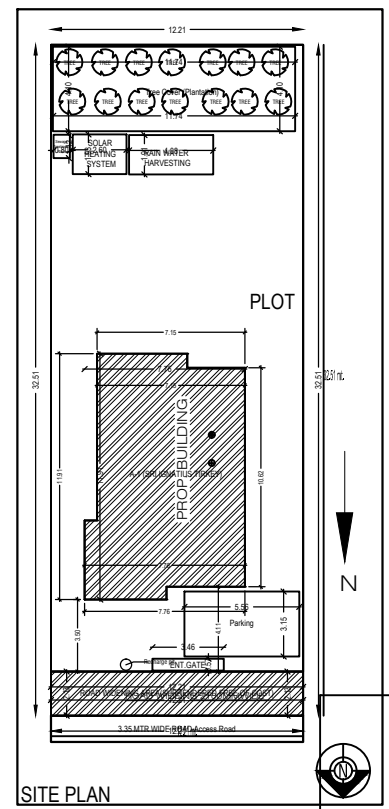
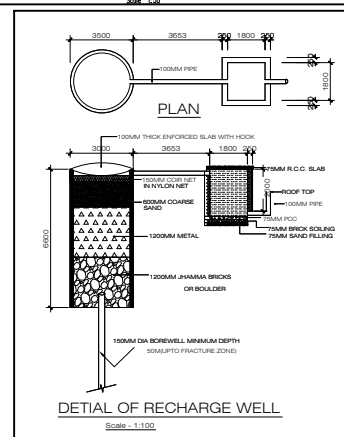
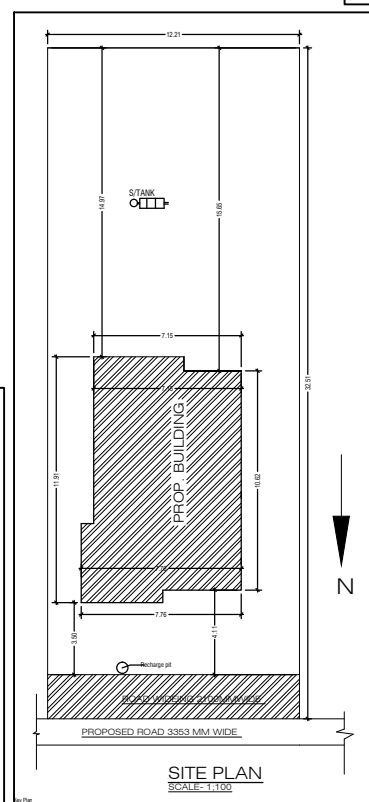
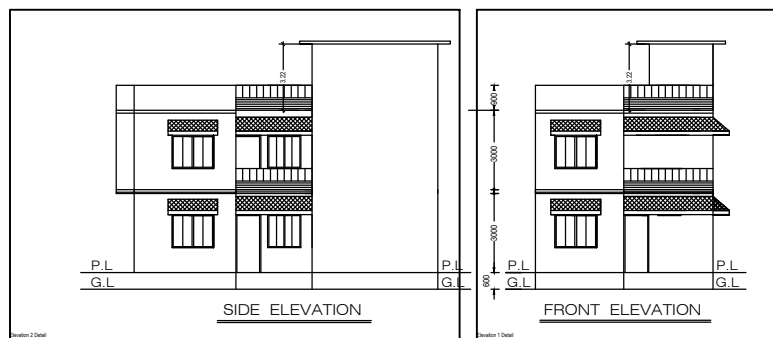
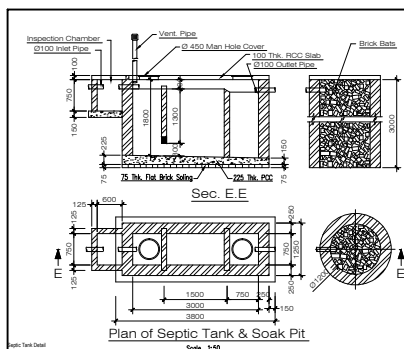
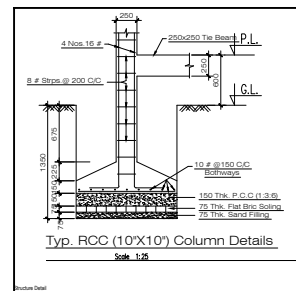
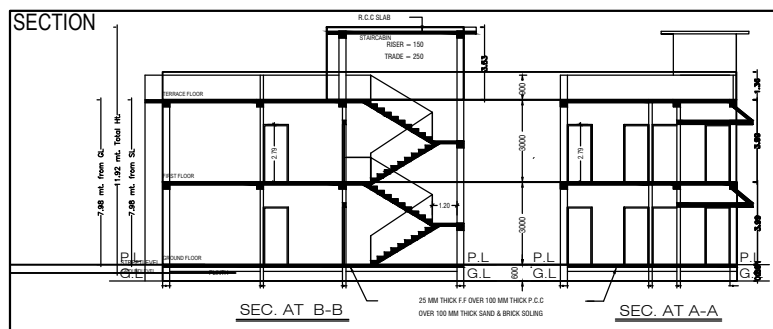

SPECIFICATION

- D.P.C 1:2:4 @ 2' / G.O.D.
- COLUMN & FOOTING R.C.C M20
- BEAMS, SLAB & LINTEL R.C.C M20
- WINDOWS-FULLY GLAZED STEEL CASSEMENT.
- WALLS:- BRICKWORK IN C.M 1:6
- DOORS:- 35MM TH. FLUSH DOORS
- PLASTER-12" TH. PLASTER ON WALL 1:6
- WALL FINISH -GYPSIUM DISTEMPER ON INSIDE ENVOICEM ON OUTSIDE.
- FLOORING- 8MM MOSAIC FINISH
- WIRING - CONCEALED COPPER WIRING

SCHEDULE OF DOORS & WINDOWS						
TYPE	WIDTH	HT	SILL	DESCRIPTION	Qty	UNIT
D	1050	2100	0.00	S&L FRAME GLAZED DOOR	1	NO.
W1	900	2100	0.00	S&L FRAME GLAZED WINDOW	1	NO.
W2	750	2100	0.00	S&L FRAME GLAZED WINDOW	1	NO.
W3	1500	1200	900	S&L FRAME GLAZED WINDOW	1	NO.
W4	1200	1200	900	S&L FRAME GLAZED WINDOW	1	NO.
W5	900	1200	900	S&L FRAME GLAZED WINDOW	1	NO.
V	800	450	1050	VENT PIPE	1	NO.

AREA STATEMENT

TOTAL PLOT AREA -	384.65 MSQ
PROPOSED FLOOR AREA	80.73 MSQ
PROPOSED FIRST FLOOR AREA	89.85 MSQ
TOTAL F.A.R =	170.58 MSQ
% OF GROUND COVERAGE-	20.99%

PROPOSED RESIDENTIAL BUILDING PLAN OF SRI IGNATIUS TIRKEY S/O CAROLUS TIRKEY RS. PLOT NO-1468, KHATA NO.-185, WARDNO.-05 THANA NO. -212, VILL.-PATRATOLI, THANA AND DISTRICT- LOHARDAGA.

SIGN. OF APPLICANT'S _____ DRAWN BY: _____

NO.	DESCRIPTION	QTY	UNIT	AMOUNT
1	AREA STATEMENT	1	NO.	100.00
2	PROJECT DETAILS	1	NO.	100.00
3	SECTION	1	NO.	100.00
4	ELEVATION	1	NO.	100.00
5	PLAN	1	NO.	100.00
6	DETAIL	1	NO.	100.00
7	TABLE	1	NO.	100.00
8	OTHER	1	NO.	100.00
9	TOTAL			700.00

COLOR INDEX						
NO.	DESCRIPTION	Color				
1	PLASTER	White				
2	WALL FINISH	White				
3	FLOORING	Mosaic				
4	WOODWORK	Teak				
5	PAINT	White				
6	ROOF FINISH	Grey				
7	CONCRETE	Grey				
8	IRONWORK	Black				
9	GLASS	Clear				

MARGIN DETAIL						
Side	Front Margin	Rear Margin	Side Margin	End Margin		
Front	3.00	14.87	1.63	2.82		
Rear						
Left						
Right						

Building A (SRI IGNATIUS TIRKEY)

Floor	Area (Sq.M)	Volume (Cu.M)	Weight (Kg)
Ground Floor	89.85	898.5	898500
1st Floor	89.85	898.5	898500
Total	179.70	1797.0	1797000

SCHEDULE OF JOINERY:

NO.	DESCRIPTION	QTY	UNIT	AMOUNT
1	GLAZED DOOR	1	NO.	100.00
2	GLAZED WINDOW	4	NO.	400.00
3	VENT PIPE	1	NO.	100.00
4	TOTAL			600.00

SCHEDULE OF JOINTS:

NO.	DESCRIPTION	QTY	UNIT	AMOUNT
1	DOOR JOINT	1	NO.	100.00
2	WINDOW JOINT	4	NO.	400.00
3	TOTAL			500.00

Unit/BUA Table for Building A (SRI IGNATIUS TIRKEY)

Floor	Area (Sq.M)	Volume (Cu.M)	Weight (Kg)
Ground Floor	89.85	898.5	898500
1st Floor	89.85	898.5	898500
Total	179.70	1797.0	1797000