

GROUND FLOOR PLAN
SCALE - 1:100

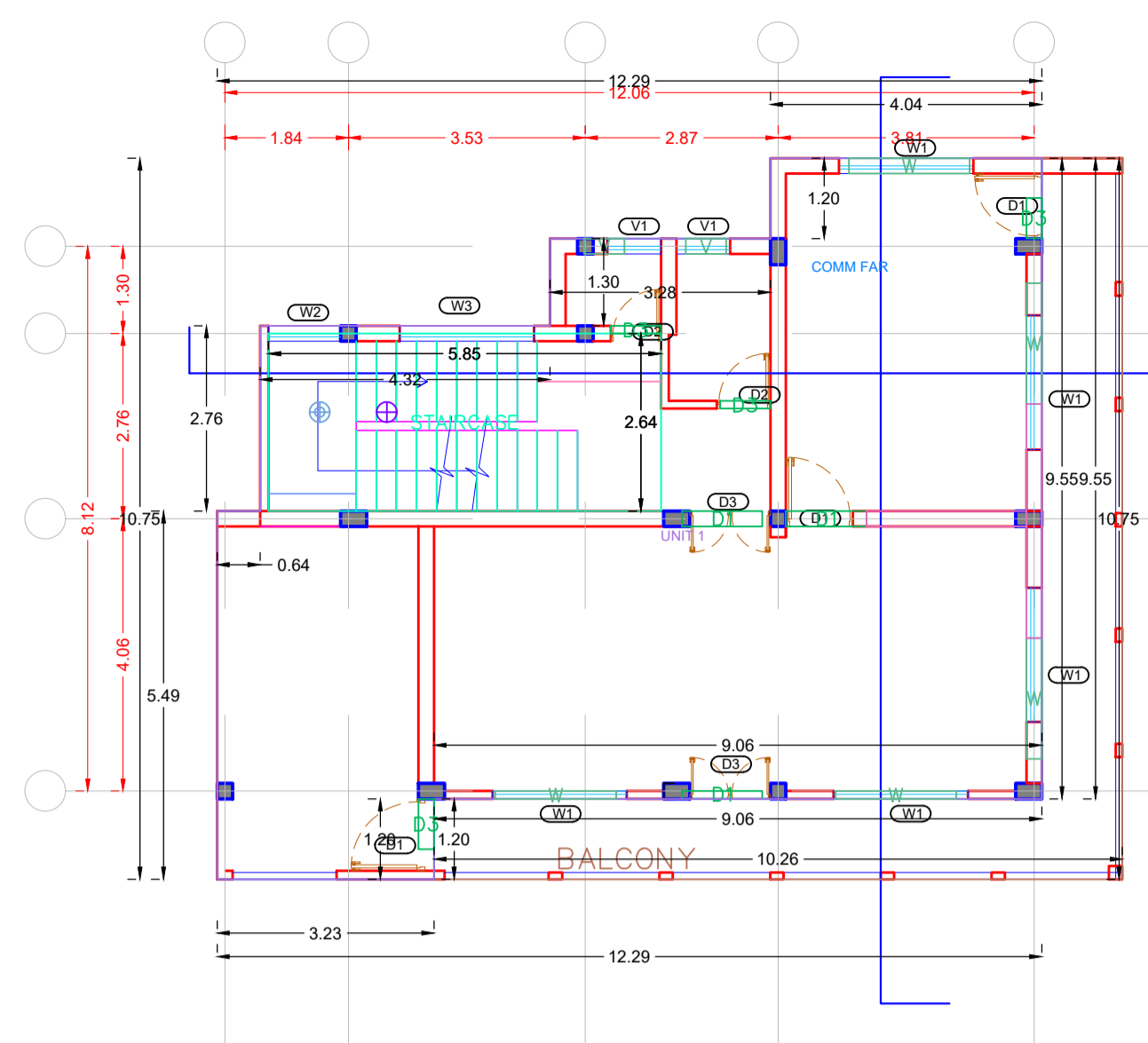

FIRST & SECOND FLOOR PLAN
SCALE - 1:100

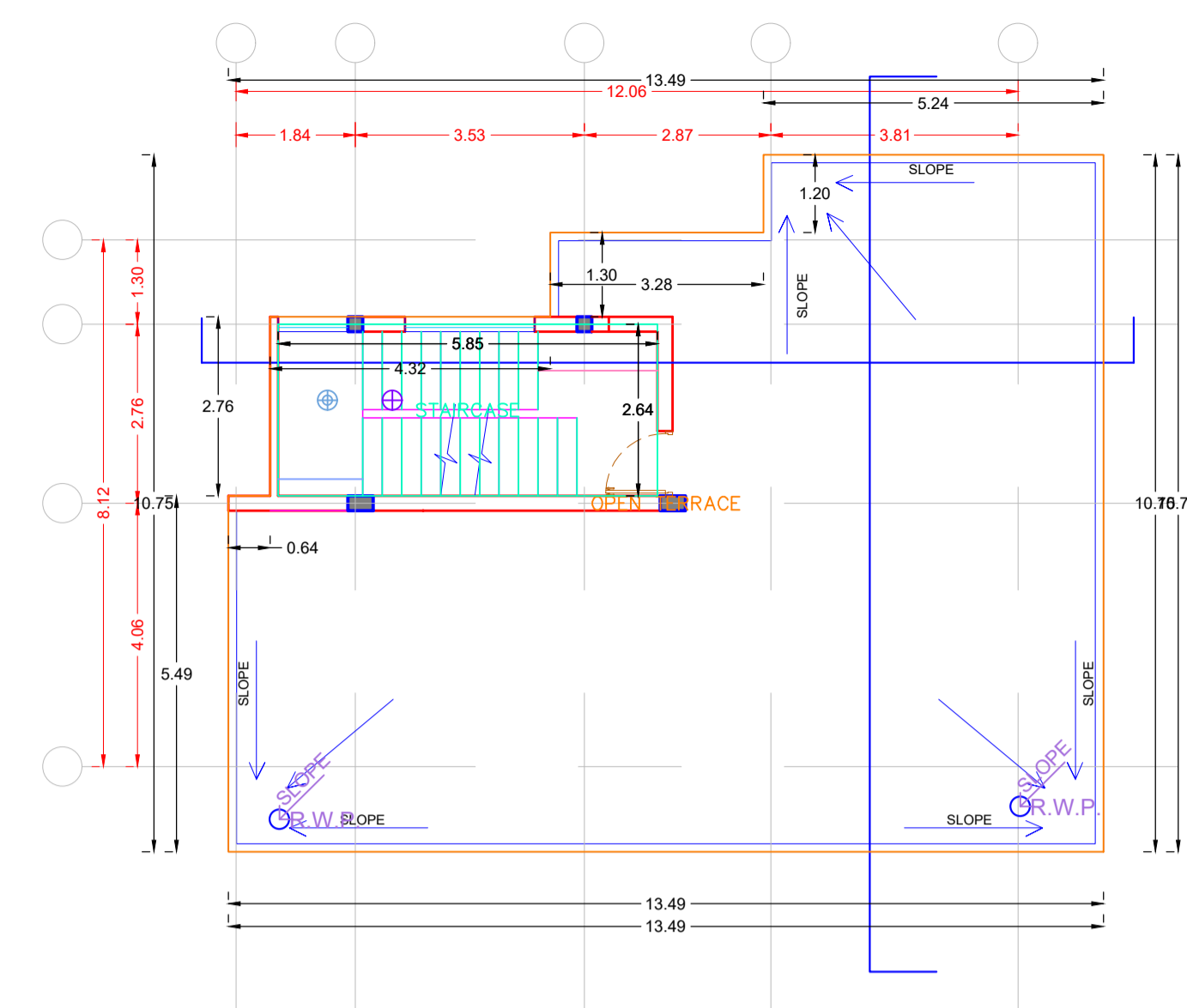

TERRACE FLOOR PLAN
SCALE - 1:100

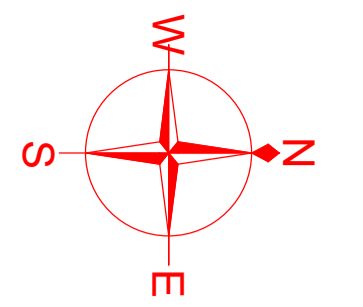

GUMLA LOHARDAGA ROAD

MITRA PETROL PUMP

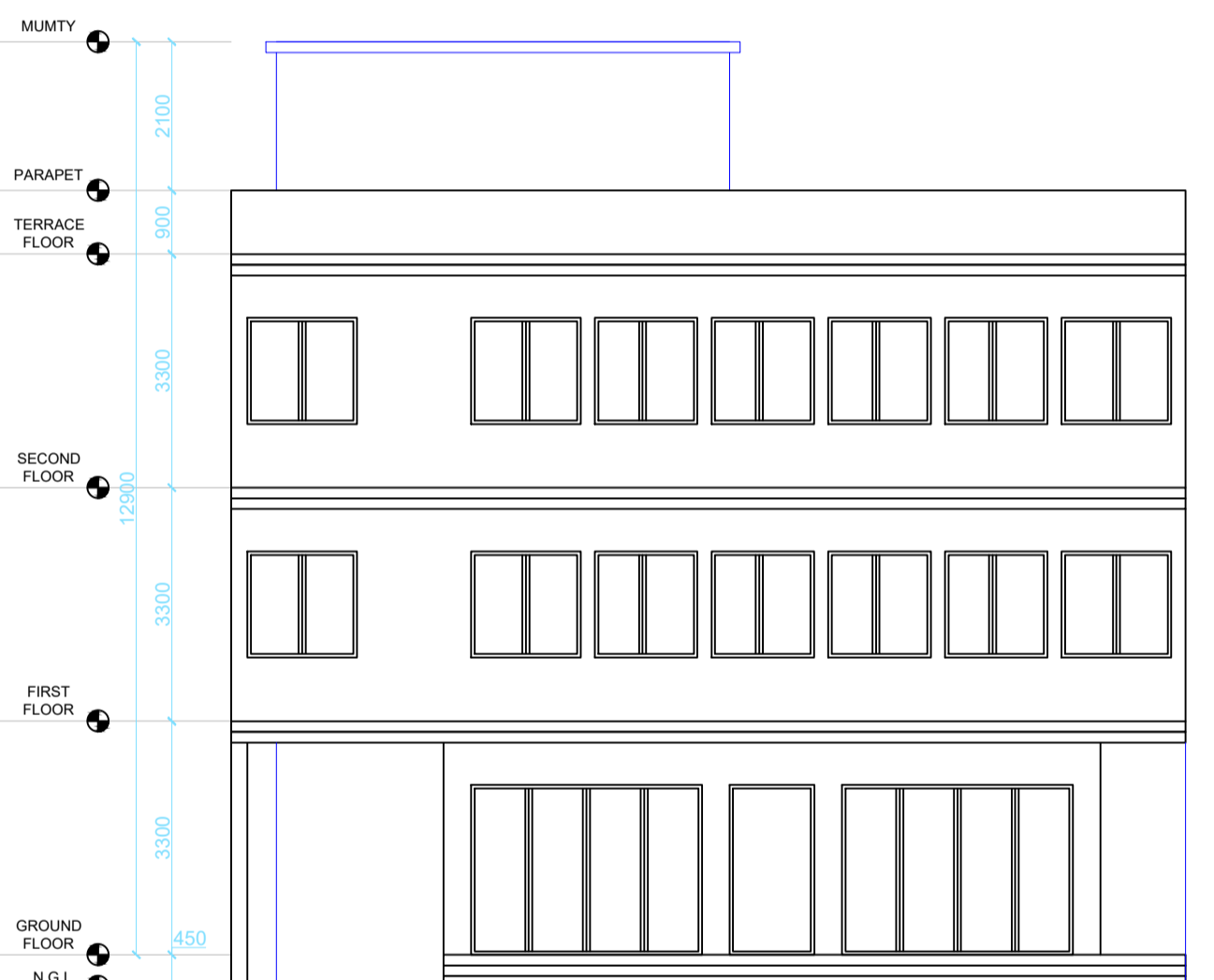

EAST SIDE ELEVATION
SCALE - 1:100

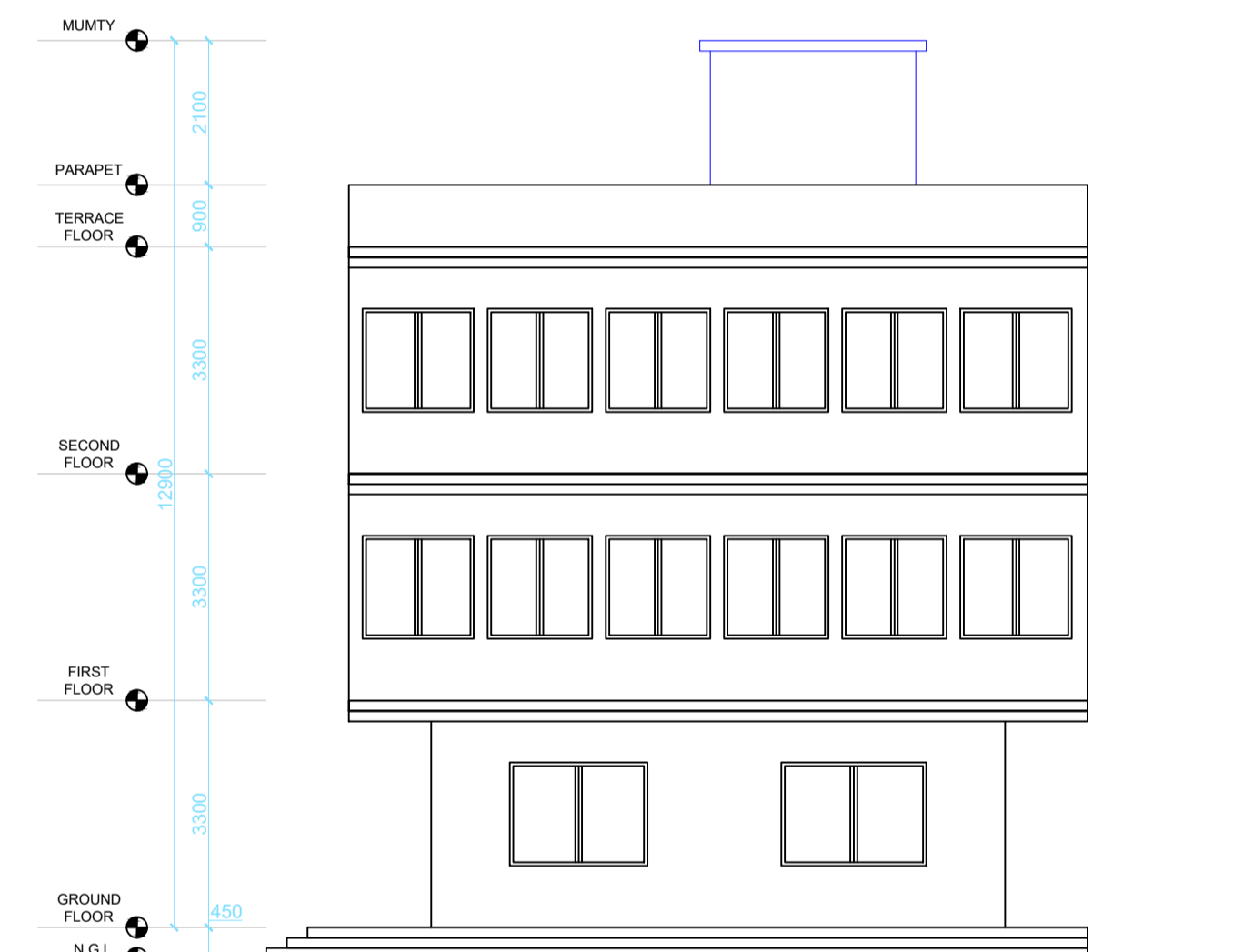

NORTH SIDE ELEVATION
SCALE - 1:100

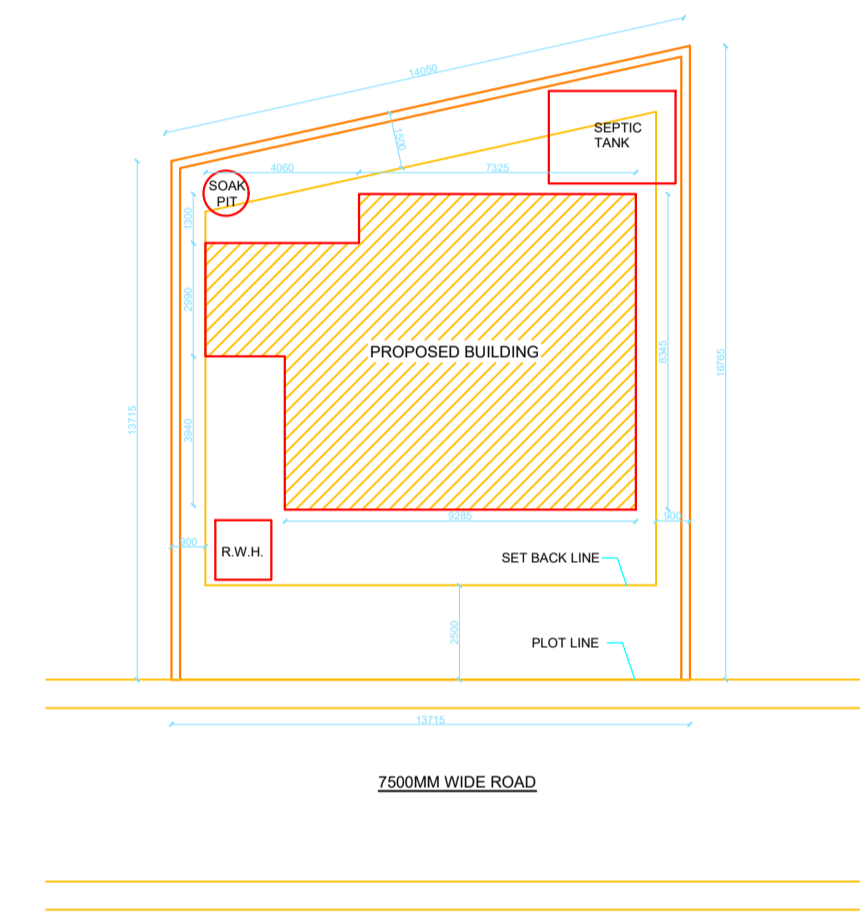

SITE PLAN
SCALE - 1:200

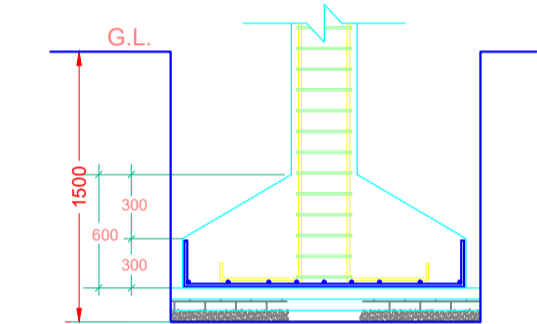

STRUCTURAL DETAIL
SCALE - NTS

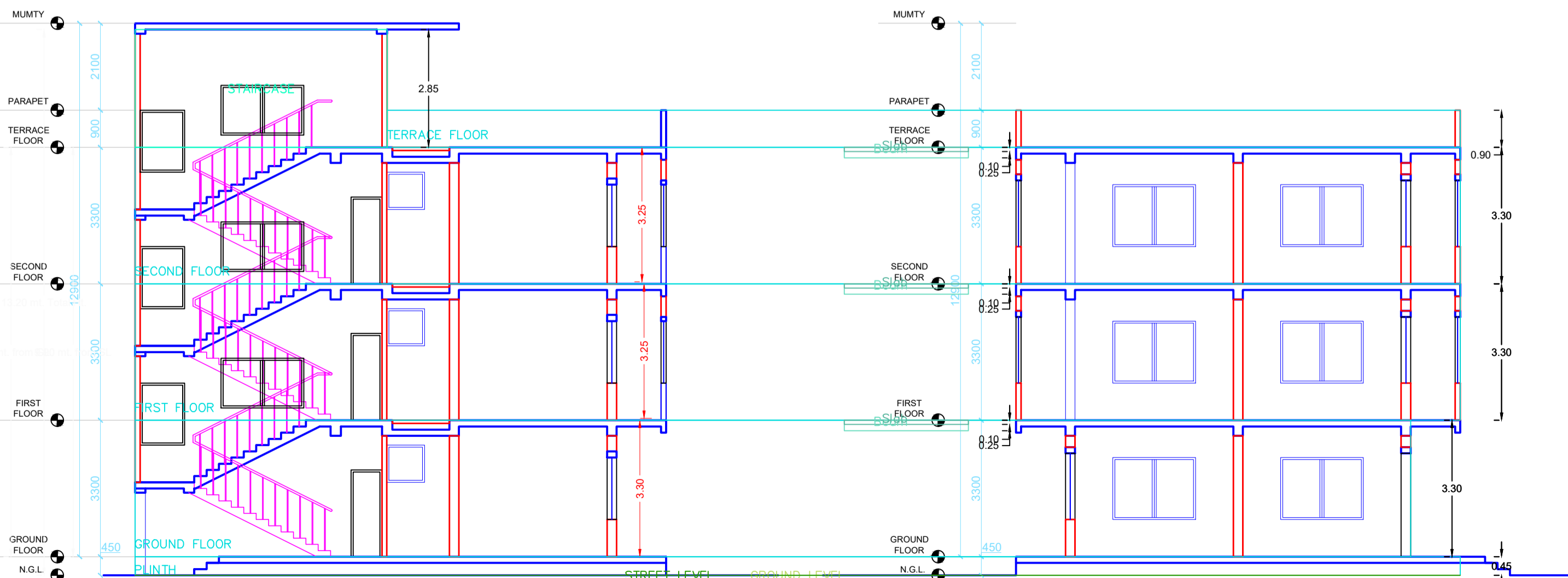

SECTION AA'
SCALE - 1:100

SECTION BB'
SCALE - 1:100

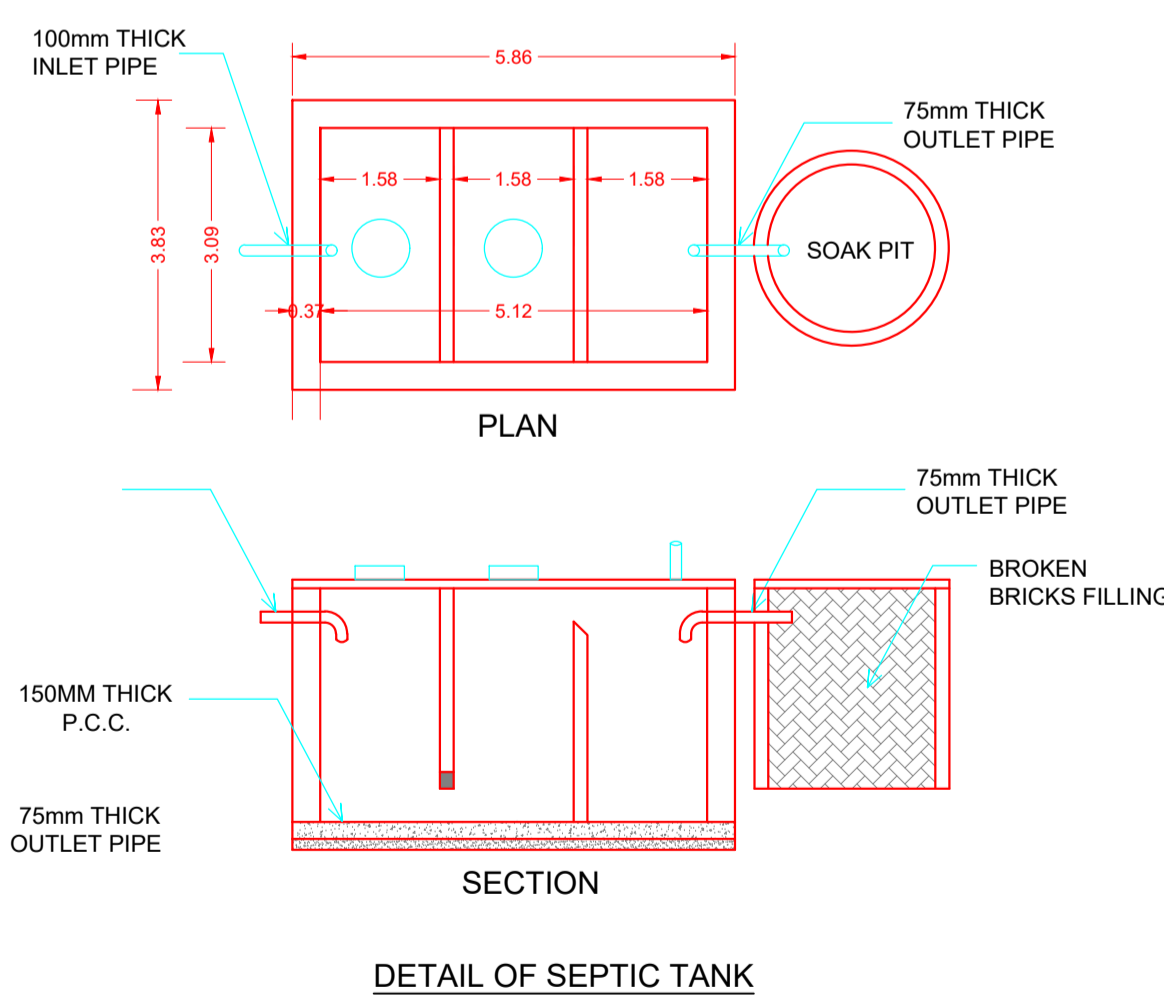

DETAIL OF SEPTIC TANK

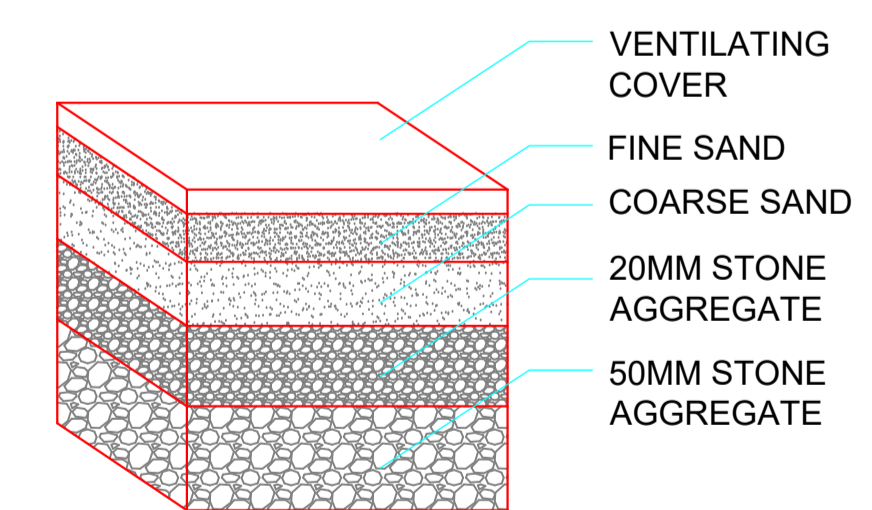

RAIN WATER HARVESTING PIT

Structure Detail

Septic Tank Detail

Rain Water Storage Tank Detail
