

Project Title :MD.SOUKAT ANSARI AND ROUSHAN ARA

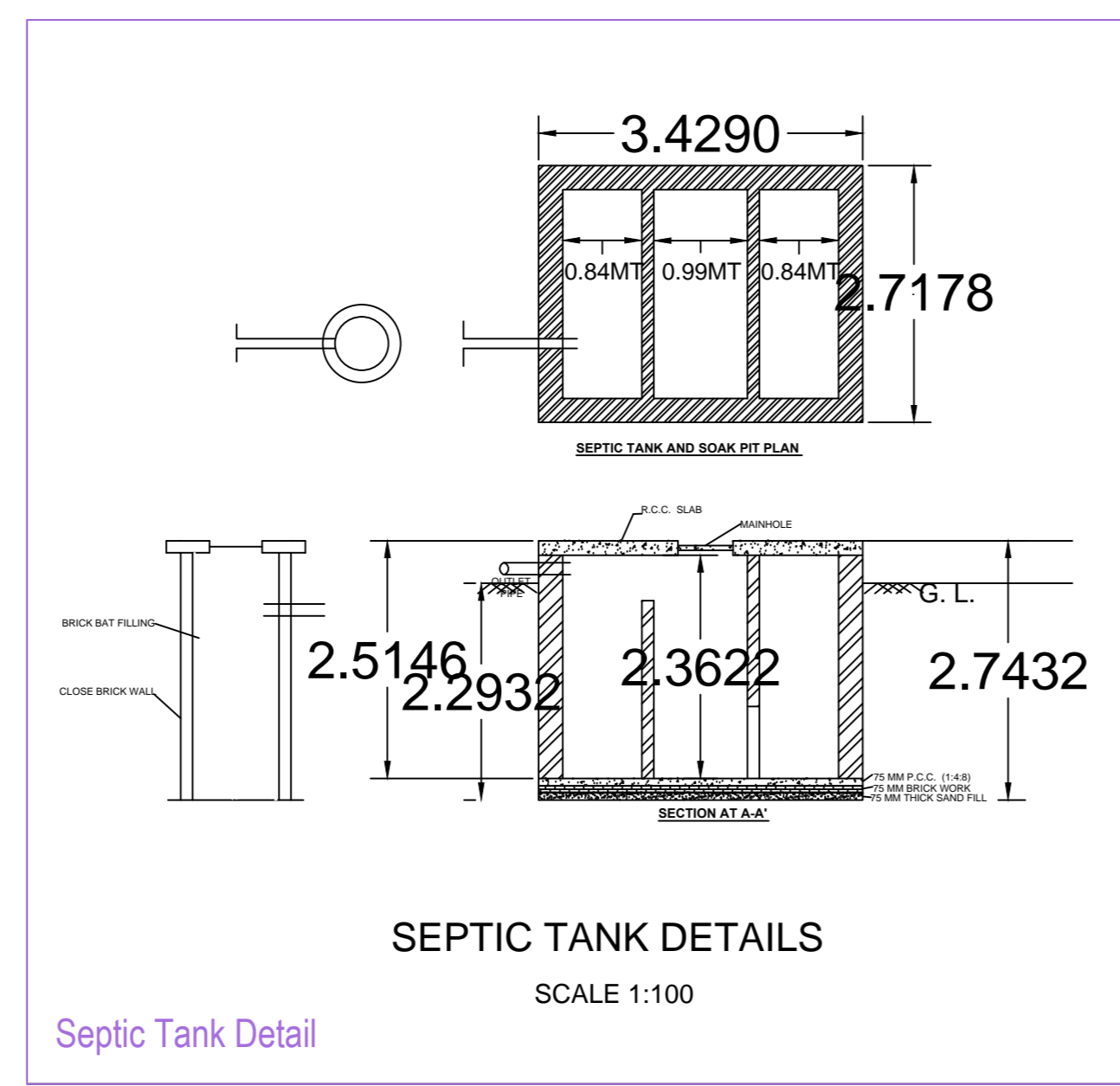

Septic Tank Detail

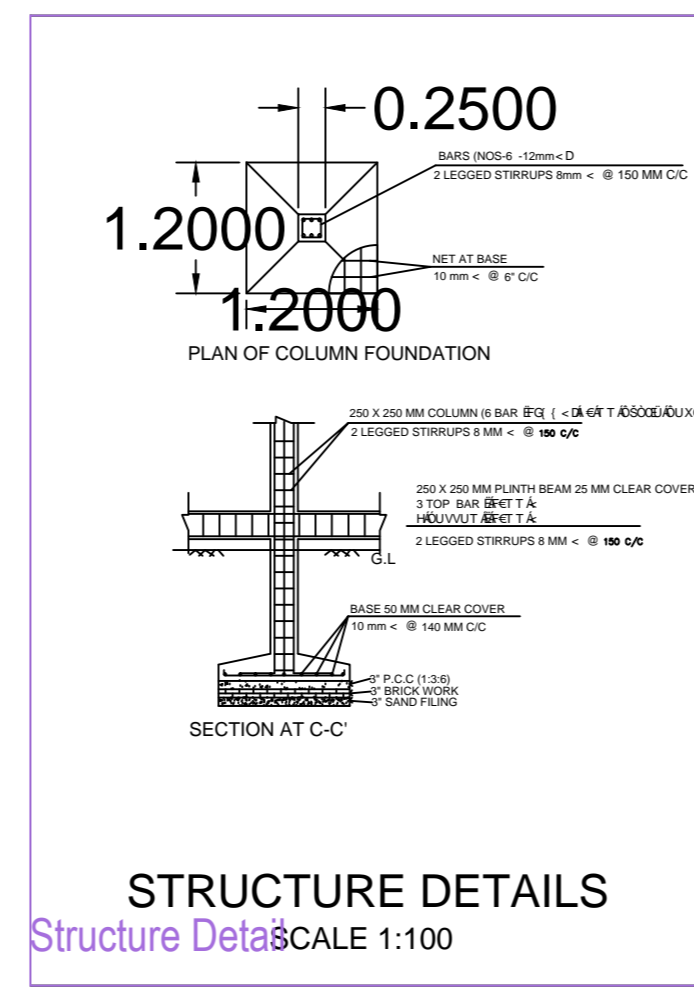

Structure Detail

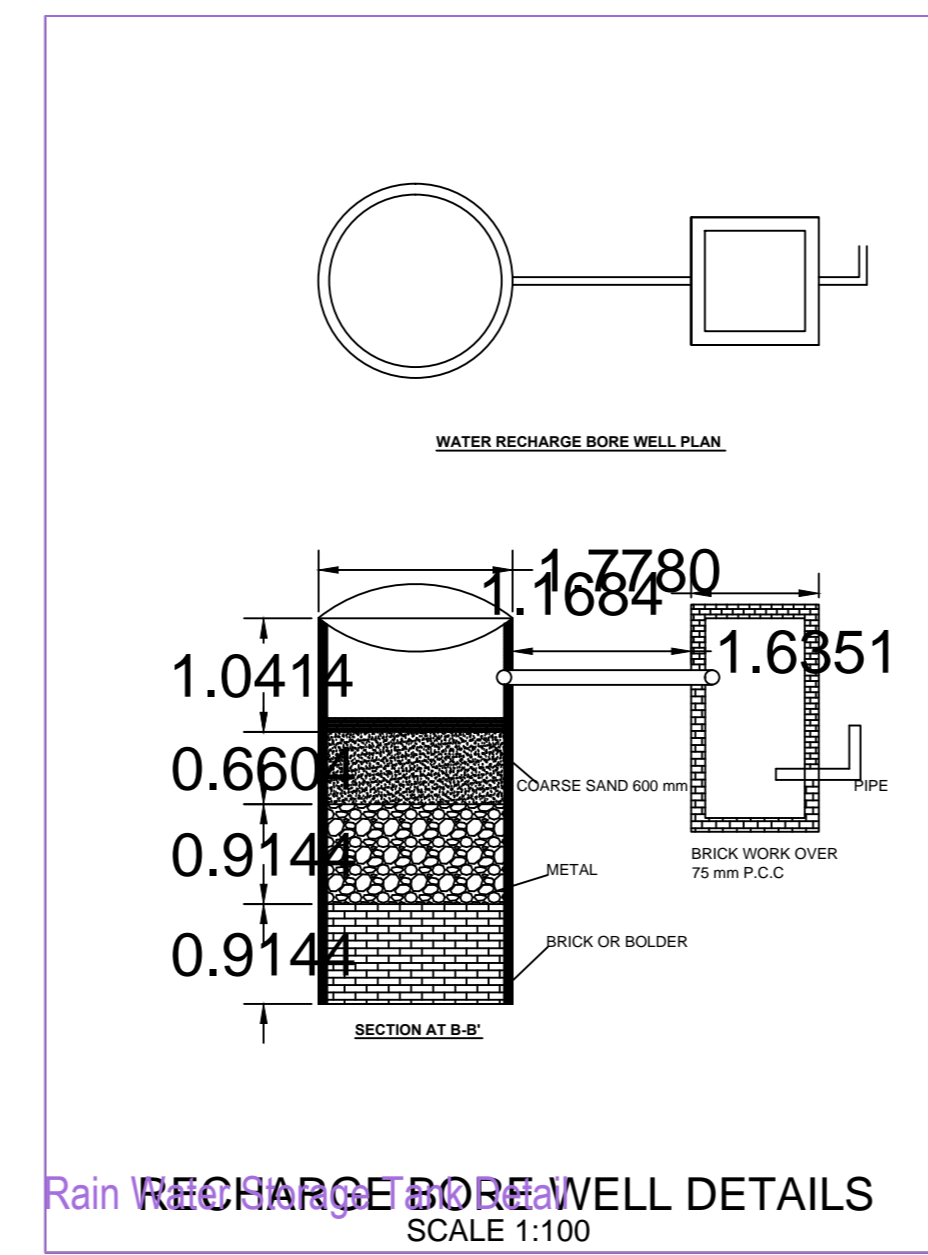

Recharge Bore Well Detail

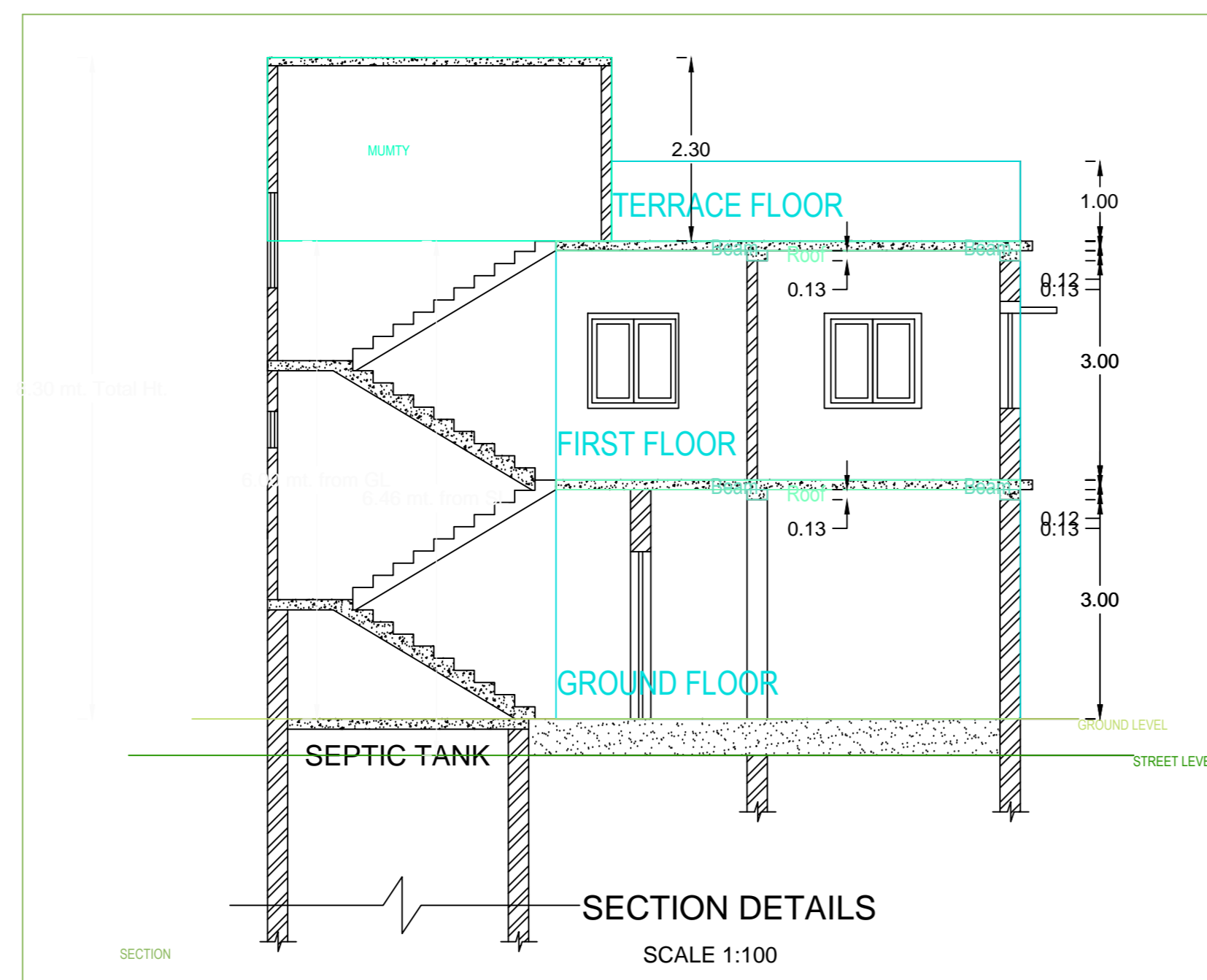

A (BUILDING)

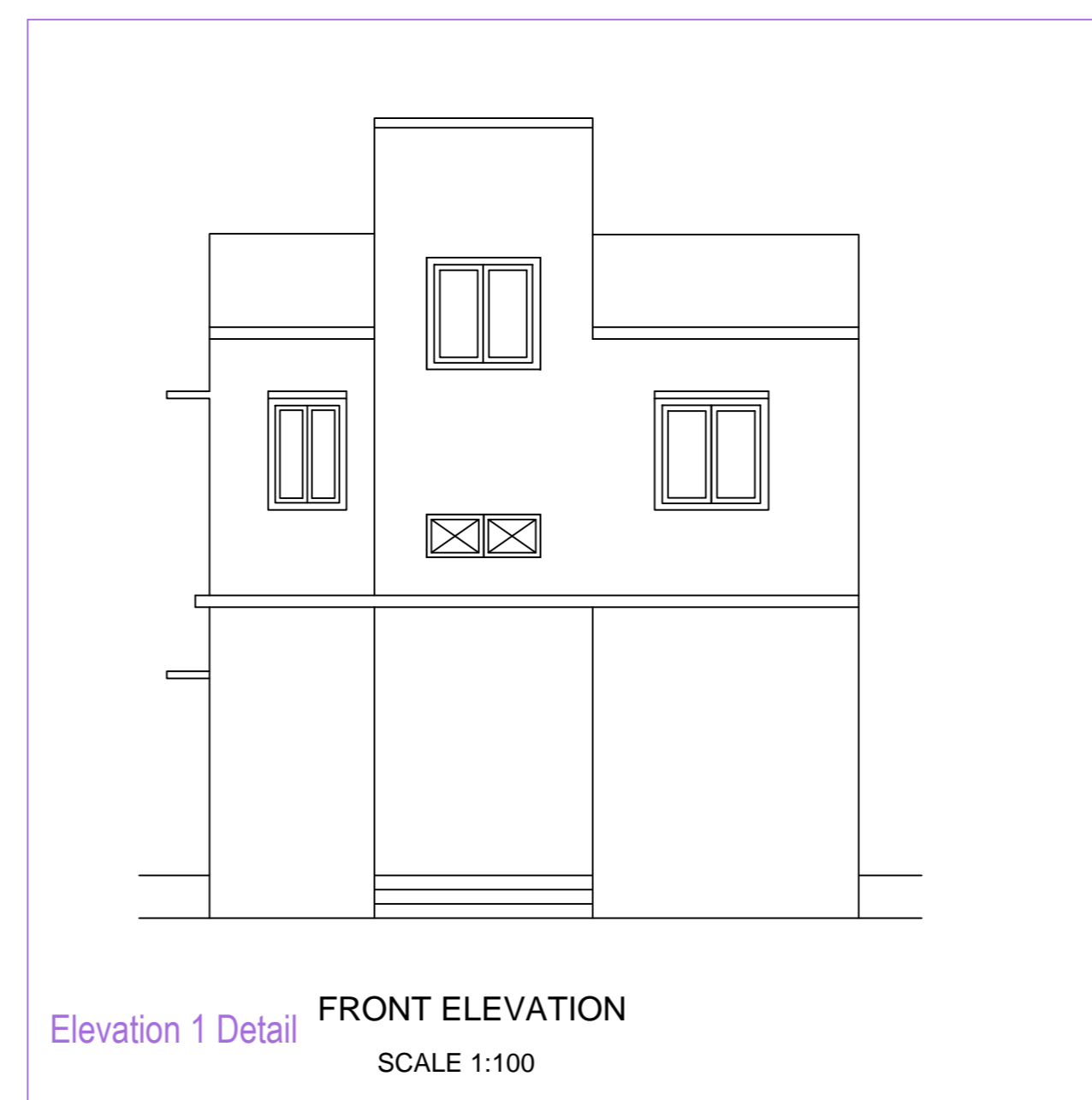

Elevation 1 Detail

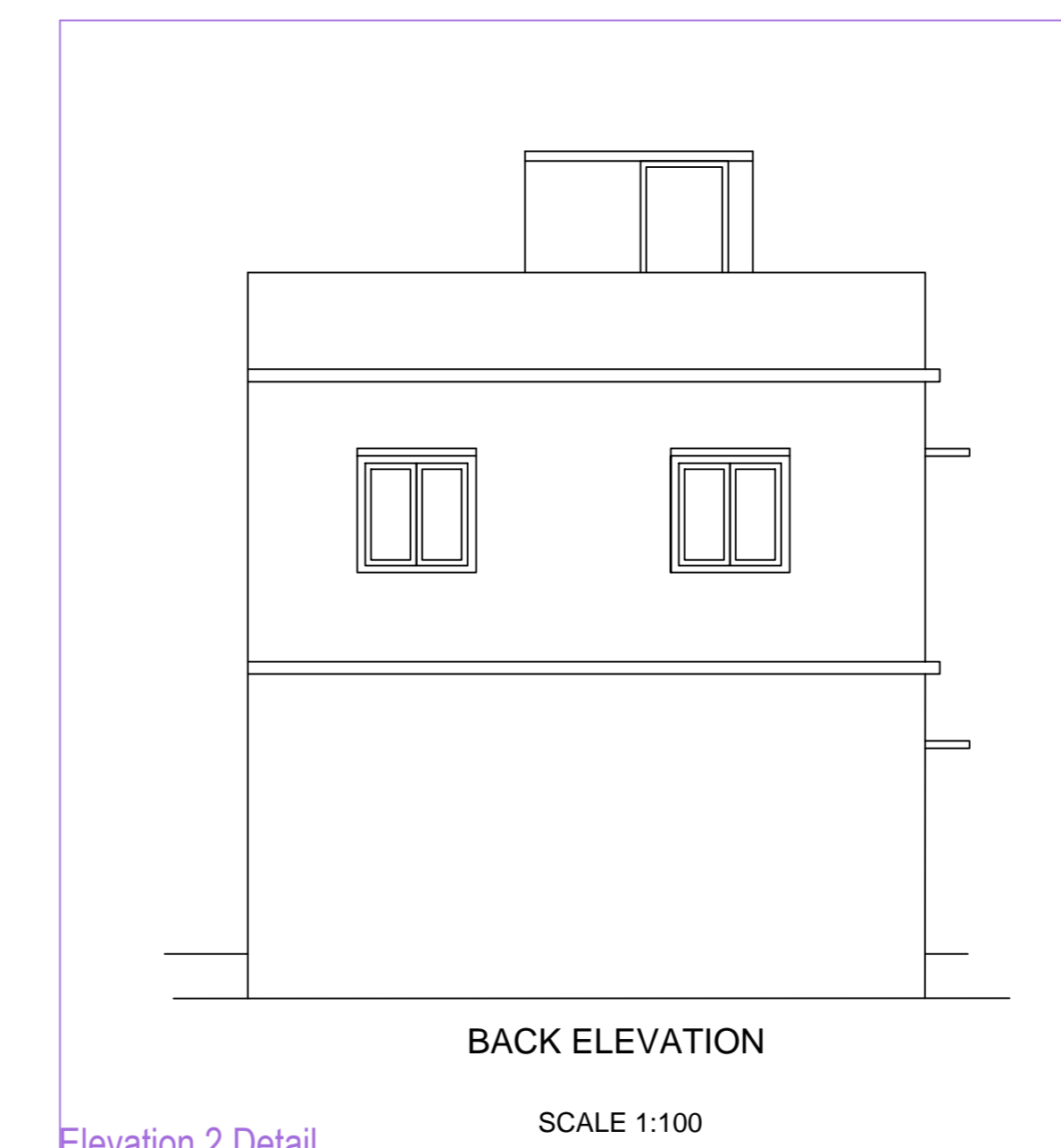

Elevation 2 Detail

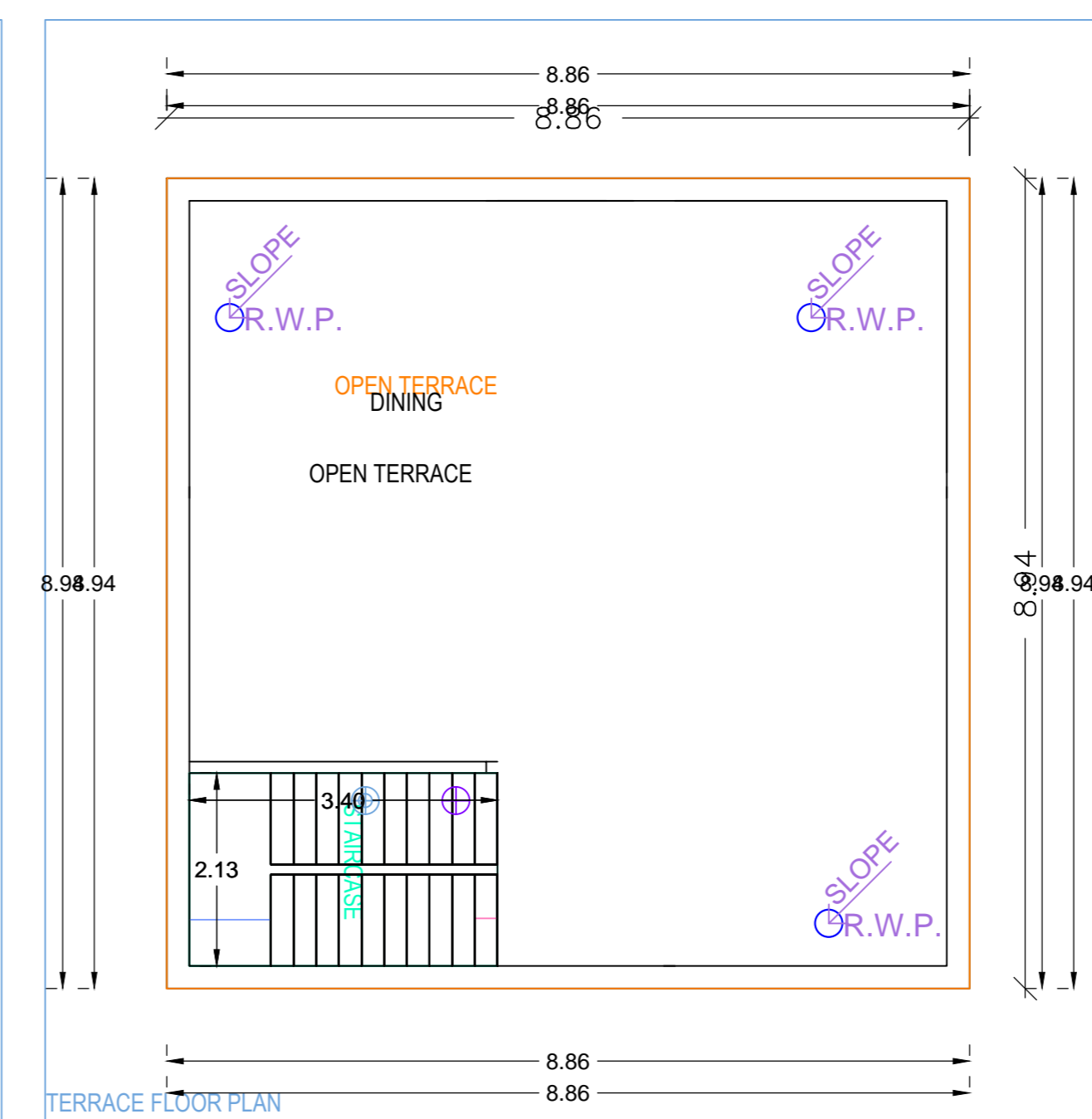
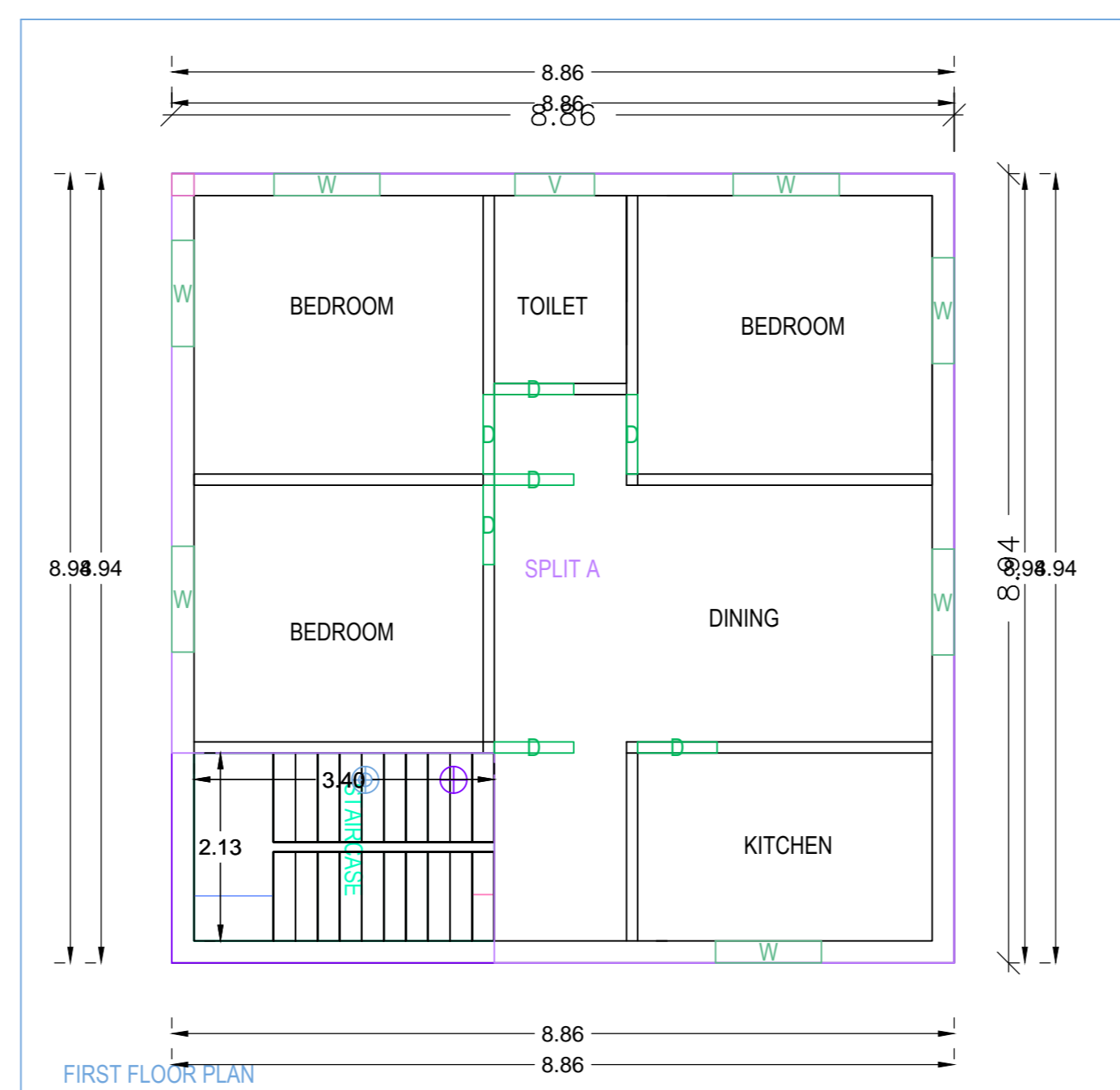
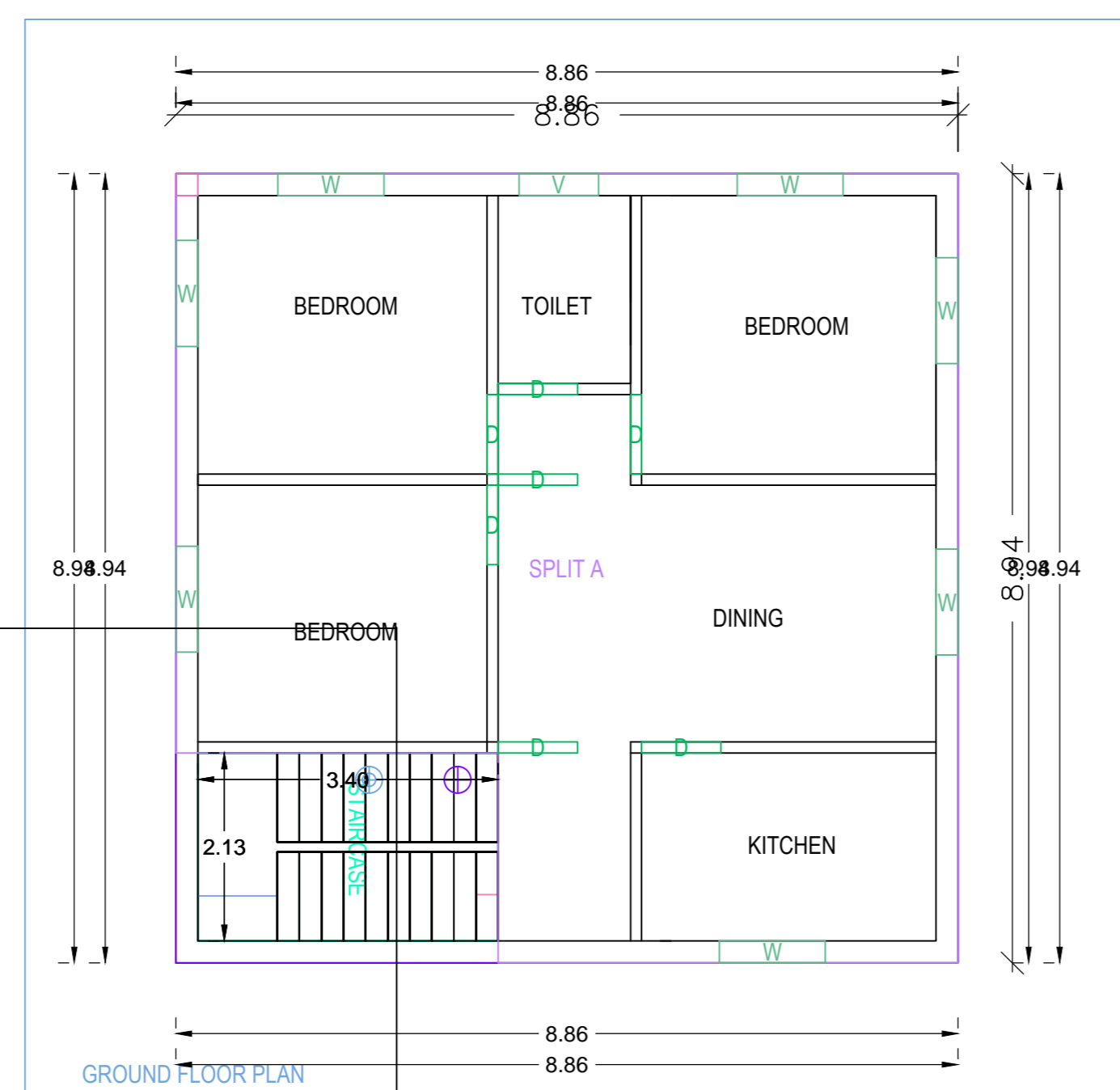
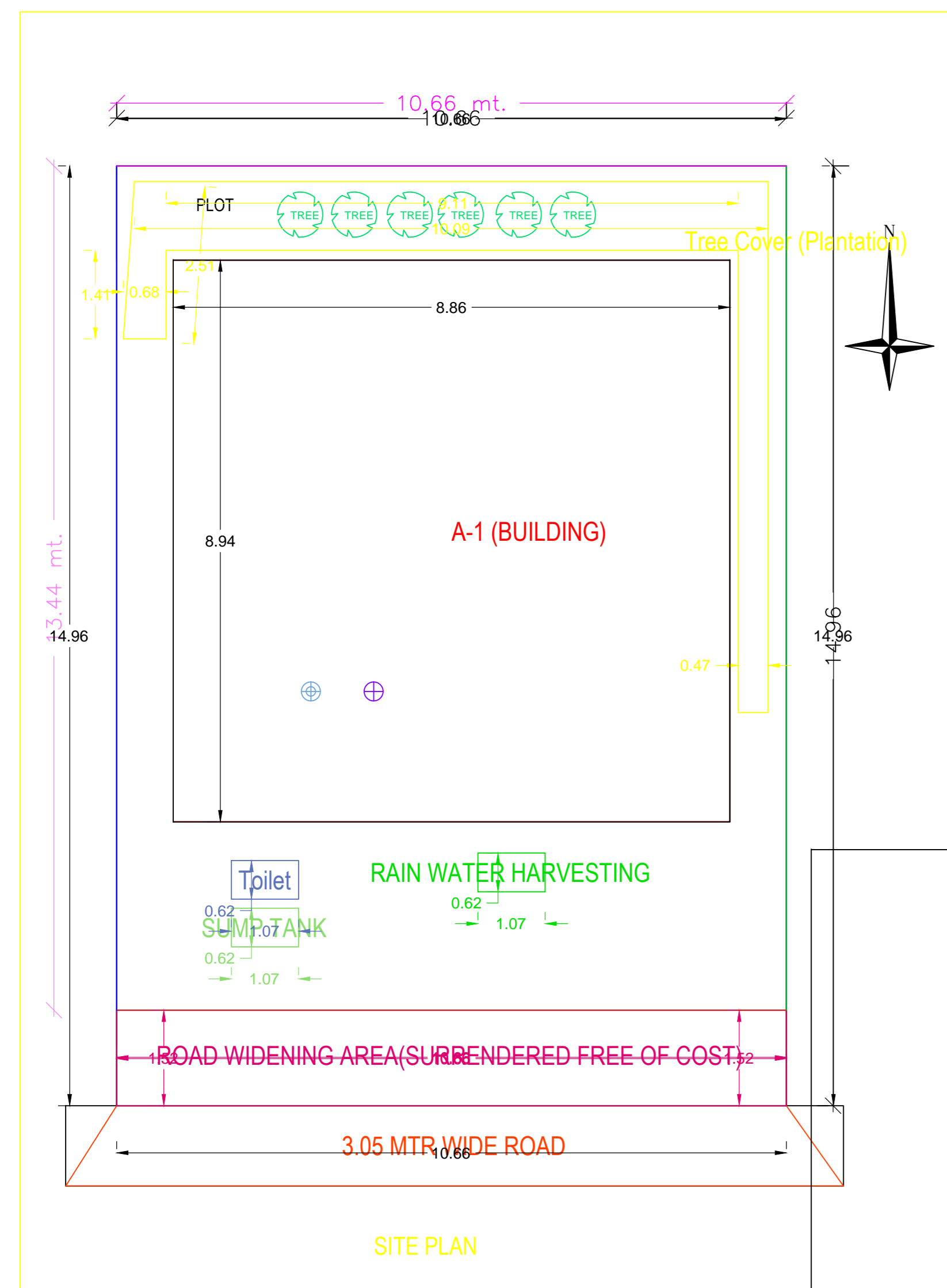

Building :A (BUILDING)

Floor Name	Total Built Up Area (Sq.mt.)	Proposed FAR Area (Sq.mt.) Resi.	Total FAR Area (Sq.mt.)	Tnmt (No.)
Ground Floor...	79.24	79.24	79.24	01
First Floor...	79.24	79.24	79.24	00
Terrace Floor...	0.00	0.00	0.00	00
Total :	158.48	158.48	158.48	01
Total Number of Same Buildings	1			
Total :	158.48	158.48	158.48	01

SCHEDULE OF JOINERY:

BUILDING NAME	NAME	LENGTH	HEIGHT	NOS
A (BUILDING)	D	0.90	2.10	14
Total	-	-	-	14

SCHEDULE OF JOINERY:

BUILDING NAME	NAME	LENGTH	HEIGHT	NOS
A (BUILDING)	V	0.90	1.00	02
A (BUILDING)	W	1.20	1.20	14
Total	-	-	-	16

UnitBUA Table for Building :A (BUILDING)

FLOOR	Name	UnitBUA Type	UnitBUA Area	Carpet Area	No. of Rooms	No. of Tenement
GROUND FLOOR PLAN	SPLIT A	FLAT	141.10	140.97	8	1
Total	-	-	141.10	140.97	16	1

AREA STATEMENT: MEDINAGAR MUNICIPAL CORPORATION	VERSION NO.: 1.0.37
PROJECT DETAIL :	VERSION DATE: 16/10/2020
Inward No. : -	Plot Use : Residential
Region : JHARKHAND URBAN LOCAL BODIES	Plot SubUse : Bungalow/ Dwelling / Non Apartment
District : PALAMU	Land Use Zone : NA
Application Type : General Proposal	Abutting Road Width : -
Project Type : Building Permission	Plot No. : -
Nature of Development : New	Revenue Survey No/Survey No : -
Location : Old Area	Thana No : -
Sub Location : NA	Holding No : -
Village/Mauza Name : -	Khata No : -
Ward No : -	North : -
Road/Street : -	South : -
	East : -
	West : -

AREA DETAILS :		SQ.MT.
AREA OF PLOT (Minimum)	(A)	159.51
Deduction for NetPlot Area		
Surrender Free of Cost		16.20
Total		143.30
Net Plot Area (Gross Plot Area - Deduction from Gross Plot area)	(A-Deductions)	143.30
Deductions for Balance Plot Area (from Gross Plot Area)		
Free Gifted RW Area		16.20
COP Area		15.48
Total		31.68
Balance Plot Area (Net Plot Area - Recreational/Amenity space)	(A-Deductions)	127.63
Plot Area for Coverage (Net Plot Area)	(A-Deductions)	143.30
Plot Area for FSI (Net Plot Area + RoadWidening Area)	(A-Deductions)	159.51
AccessoryUse Area		0.66
COVERAGE CHECK		
Proposed Coverage Area (55.30 %)		79.24
Total Coverage Area (55.30 %)		79.24
FAR CHECK		
Proposed Area of FAR		158.48
Total Area of FAR		158.48
BUILT UP AREA CHECK		
Total Proposed BuiltUp Area		158.48
ARCH / ENGG / SUPERVISOR (Regd)		OWNER
DEVELOPMENT AUTHORITY		LOCAL BODY

COLOR INDEX

PLOT BOUNDARY	Black
ABUTTING ROAD	Green
PROPOSED WORK (COVERAGE AREA)	Red
EXISTING (To be retained)	Blue
EXISTING (To be demolished)	Yellow

Color Index:

MARGIN DETAIL:

Building / Wing Name	Road Name	Front Margin	Rear Margin	Side1 Margin	Side2 Margin
A-1 (BUILDING)	ROAD WIDENING AREA(SURRENDERED FREE OF COST)	3.00	1.50	0.90	0.90

FAR & Tenement Details (Table 4c-1)

Building	No. of Same Bldg	Total Built Up Area (Sq.mt.)	Proposed FAR Area (Sq.mt.) Resi.	Total FAR Area (Sq.mt.)	Tnmt (No.)
A (BUILDING)	1	158.48	158.48	158.48	01
Grand Total :	1	158.48	158.48	158.48	01