

GROUND FLOOR PLAN

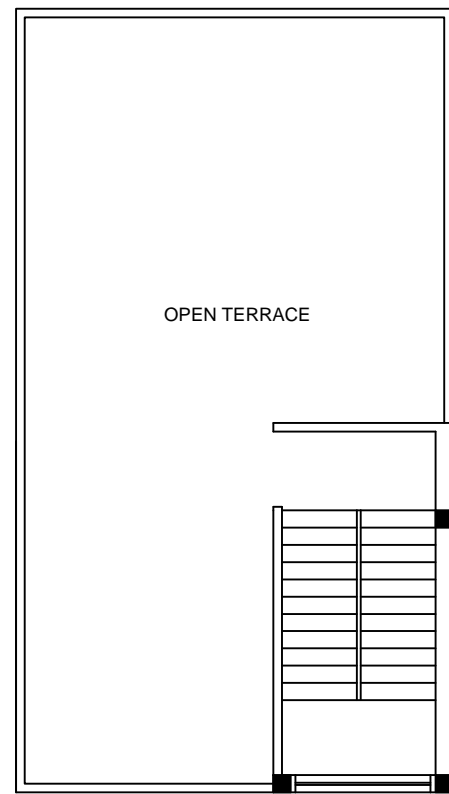

TERRACE PLAN

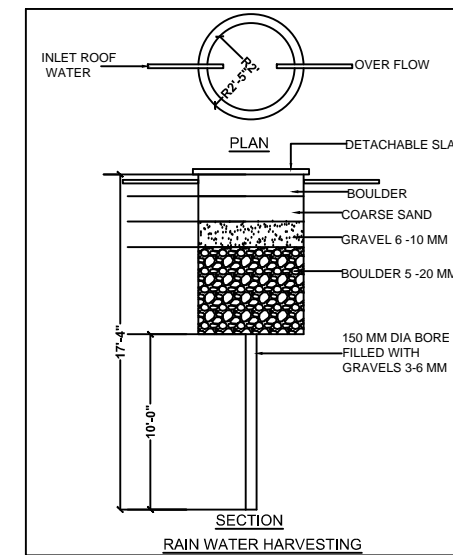
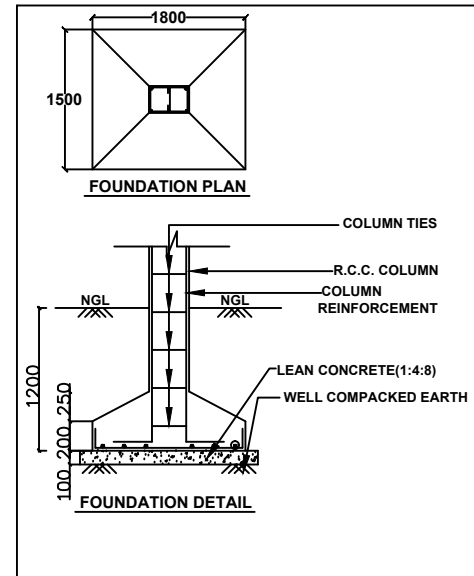

KEY PLAN

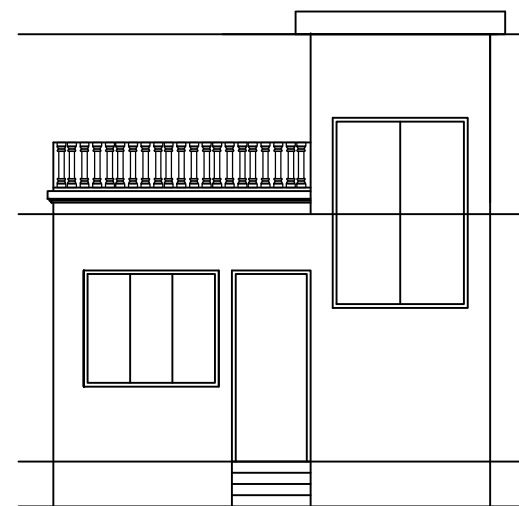
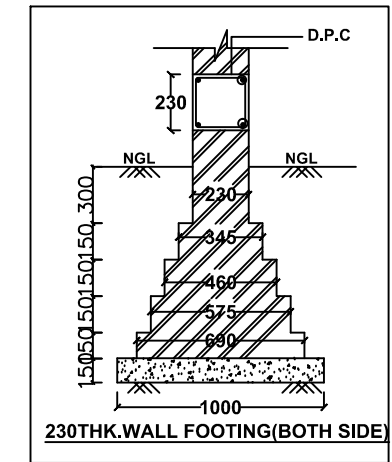
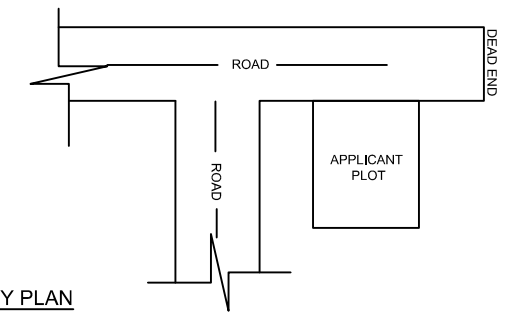

FRONT ELEVATION

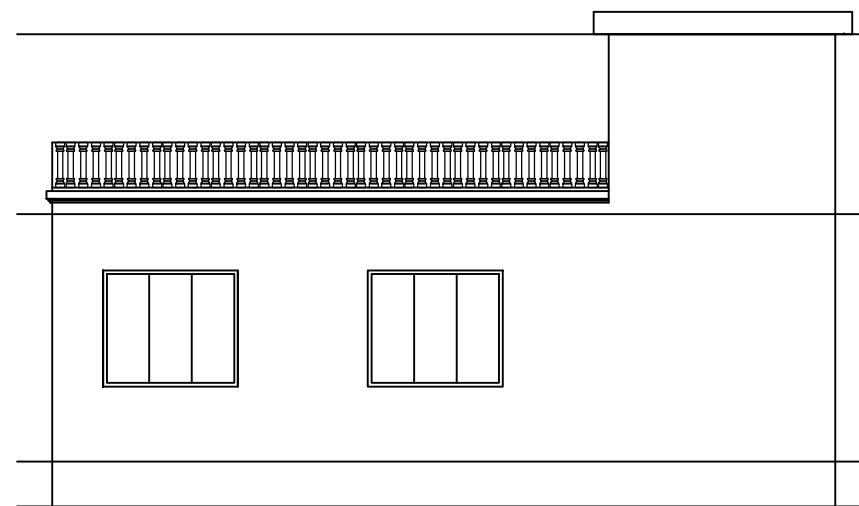

LEFT SIDE ELEVATION

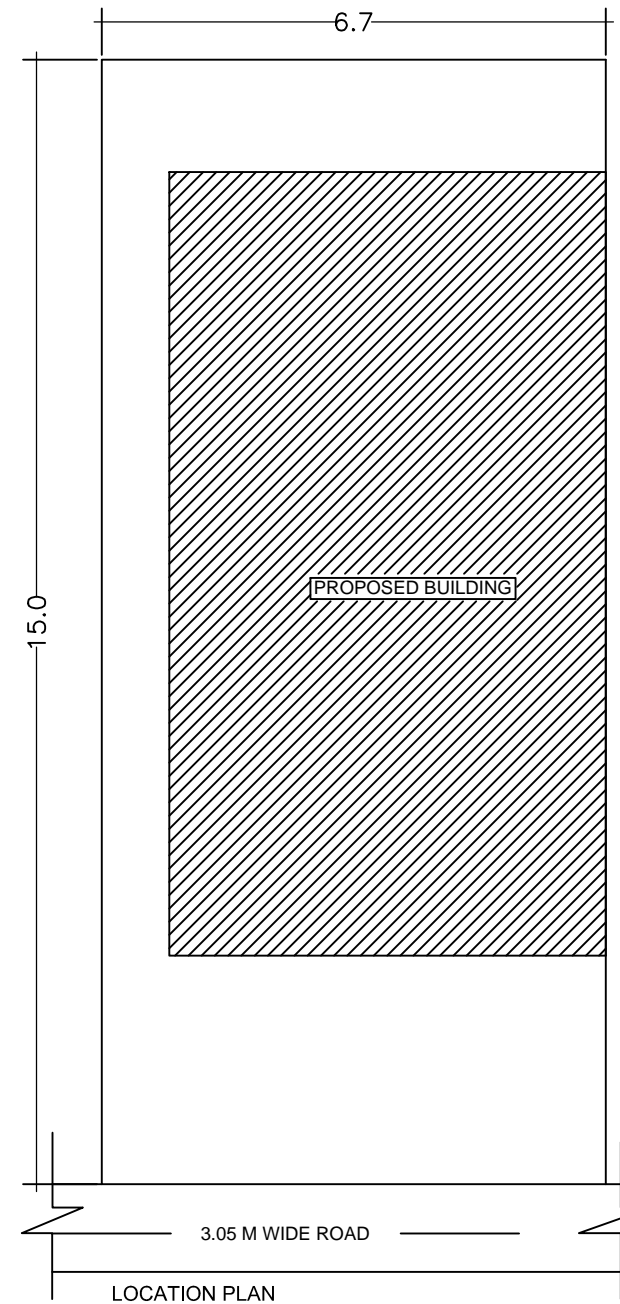

LOCATION PLAN

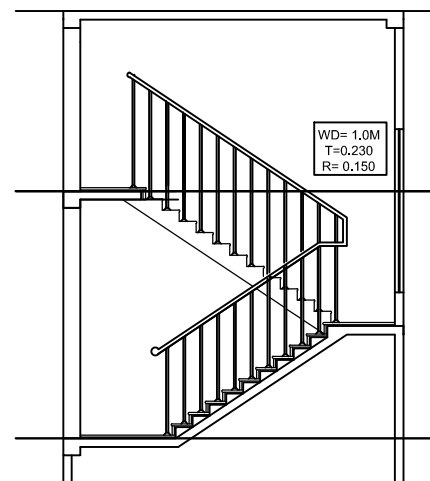
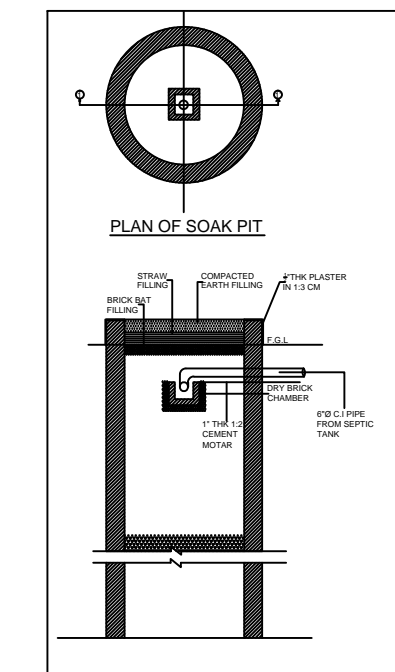
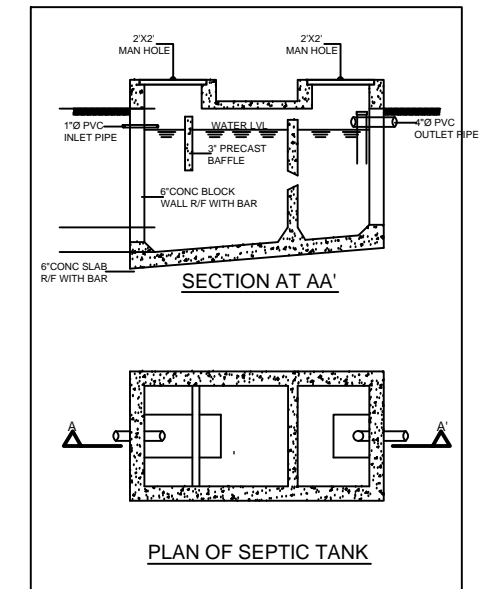

SECTION AT - XX'

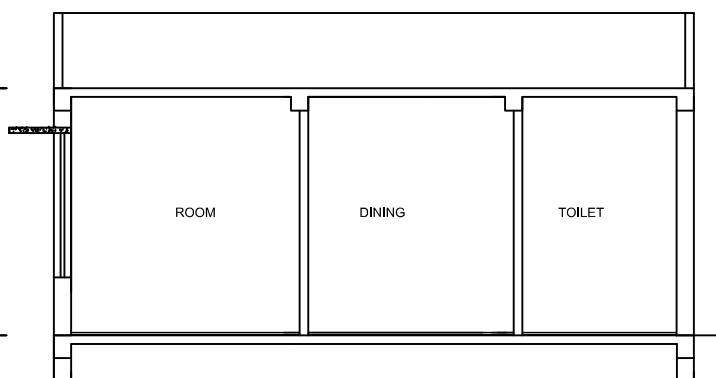

SECTION AT - YY'