

Project Title : OWNER BHADI SAW

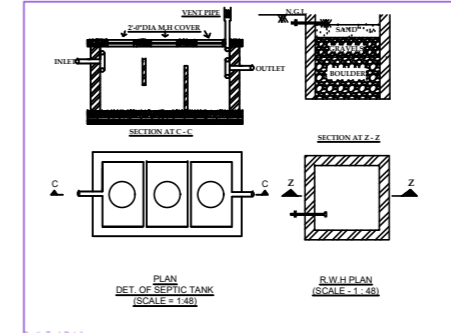
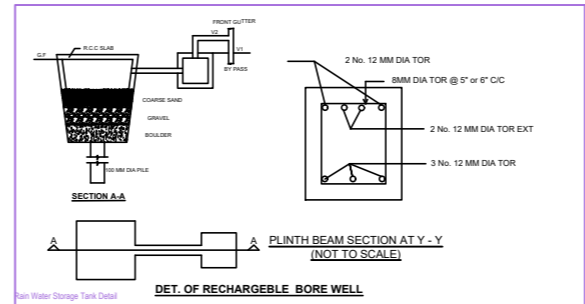
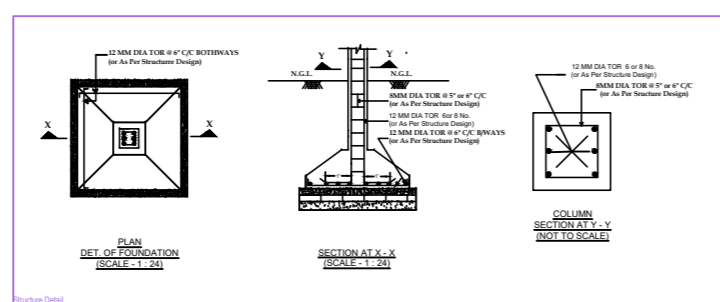

SIGN WITH SEAL BY AUTH. AUTHORITY

**SPECIFICATION**

1. Foundations - All dimensions are mentioned in feet & inches.
2. Foundations - All dimensions are mentioned in feet & inches.
3. Foundations - All dimensions are mentioned in feet & inches.
4. Foundations - All dimensions are mentioned in feet & inches.
5. Foundations - All dimensions are mentioned in feet & inches.
6. Foundations - All dimensions are mentioned in feet & inches.
7. Foundations - All dimensions are mentioned in feet & inches.
8. Foundations - All dimensions are mentioned in feet & inches.
9. Foundations - All dimensions are mentioned in feet & inches.
10. Foundations - All dimensions are mentioned in feet & inches.
11. Foundations - All dimensions are mentioned in feet & inches.
12. Foundations - All dimensions are mentioned in feet & inches.
13. Foundations - All dimensions are mentioned in feet & inches.
14. Foundations - All dimensions are mentioned in feet & inches.
15. Foundations - All dimensions are mentioned in feet & inches.
16. Foundations - All dimensions are mentioned in feet & inches.
17. Foundations - All dimensions are mentioned in feet & inches.
18. Foundations - All dimensions are mentioned in feet & inches.
19. Foundations - All dimensions are mentioned in feet & inches.
20. Foundations - All dimensions are mentioned in feet & inches.

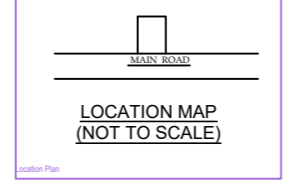
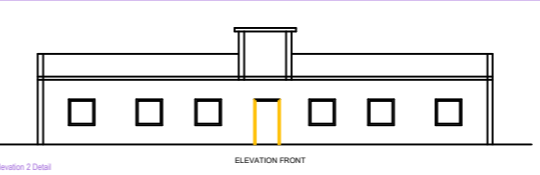
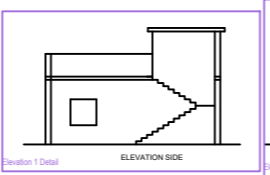
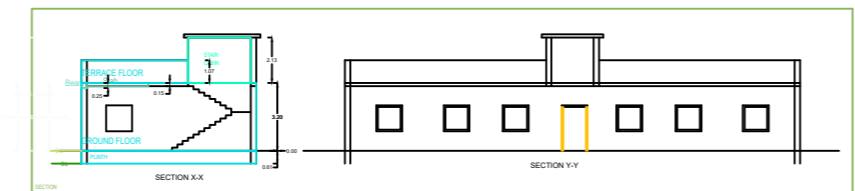
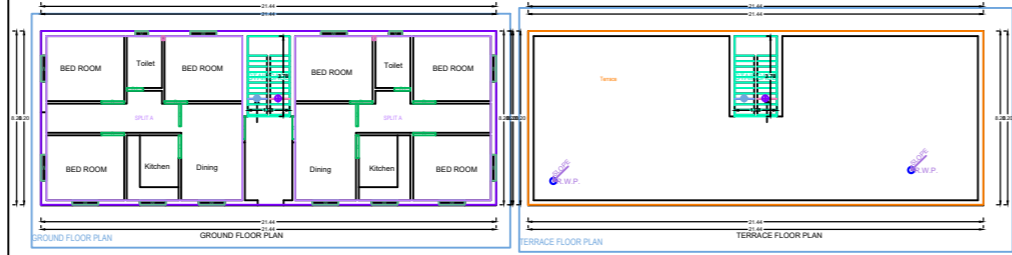
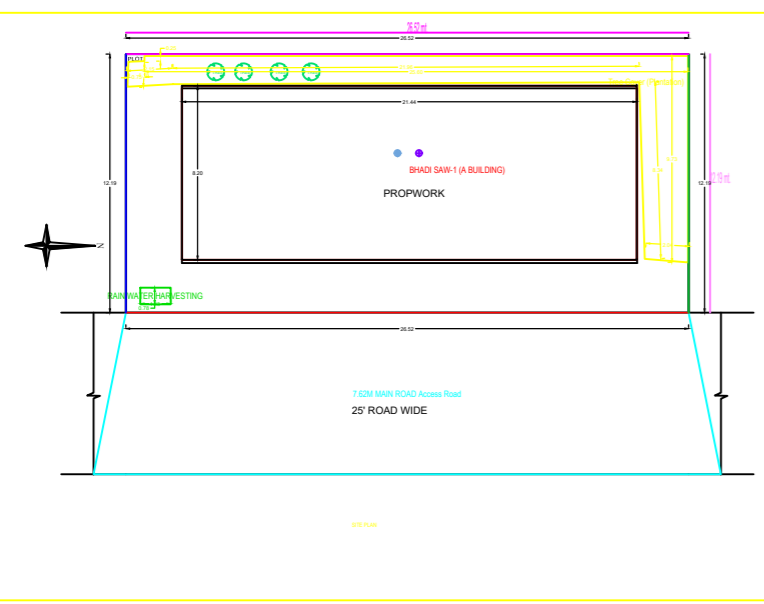

OWNER: ARCHITECT: ENGINEER:

**Building (BHADI SAW) (A BUILDING)**

Room No.	Room Name	Area (sq. ft.)	Volume (cu. ft.)	Height (ft.)
101	Bed Room	100	1000	10
102	Bed Room	100	1000	10
103	Bed Room	100	1000	10
104	Bed Room	100	1000	10
105	Bed Room	100	1000	10
106	Bed Room	100	1000	10
107	Bed Room	100	1000	10
108	Bed Room	100	1000	10
109	Bed Room	100	1000	10
110	Bed Room	100	1000	10
111	Bed Room	100	1000	10
112	Bed Room	100	1000	10
113	Bed Room	100	1000	10
114	Bed Room	100	1000	10
115	Bed Room	100	1000	10
116	Bed Room	100	1000	10
117	Bed Room	100	1000	10
118	Bed Room	100	1000	10
119	Bed Room	100	1000	10
120	Bed Room	100	1000	10

**Color Index**

Color	Material
Red	Concrete
Green	Brick
Blue	Plaster
Yellow	Wood
Purple	Paint

**Schedule of Area**

Room No.	Room Name	Area (sq. ft.)	Volume (cu. ft.)	Height (ft.)
101	Bed Room	100	1000	10
102	Bed Room	100	1000	10
103	Bed Room	100	1000	10
104	Bed Room	100	1000	10
105	Bed Room	100	1000	10
106	Bed Room	100	1000	10
107	Bed Room	100	1000	10
108	Bed Room	100	1000	10
109	Bed Room	100	1000	10
110	Bed Room	100	1000	10
111	Bed Room	100	1000	10
112	Bed Room	100	1000	10
113	Bed Room	100	1000	10
114	Bed Room	100	1000	10
115	Bed Room	100	1000	10
116	Bed Room	100	1000	10
117	Bed Room	100	1000	10
118	Bed Room	100	1000	10
119	Bed Room	100	1000	10
120	Bed Room	100	1000	10