

FRONT ELEVATION

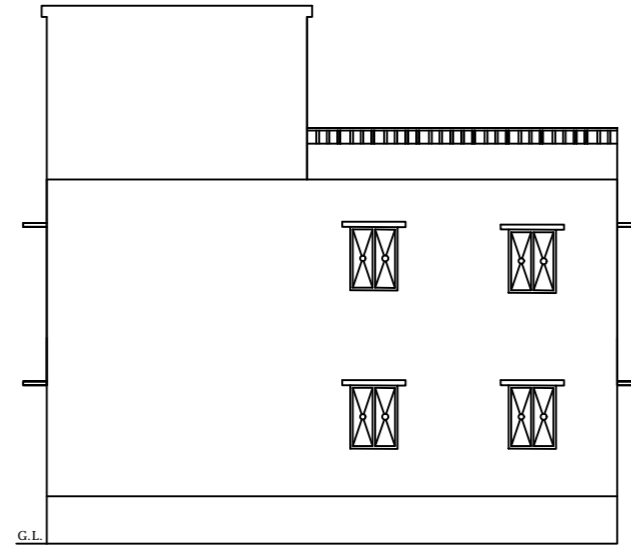

EAST SIDE ELEVATION

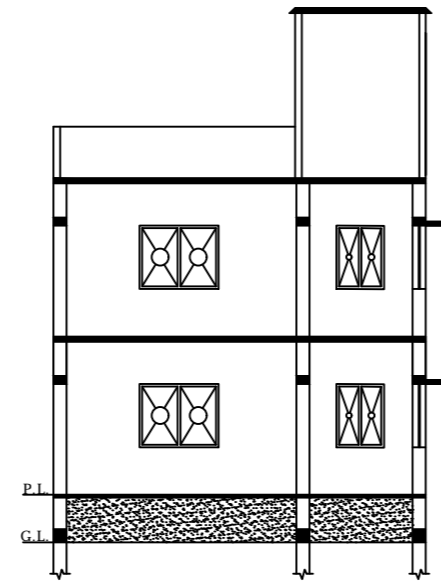

SECTION- YY

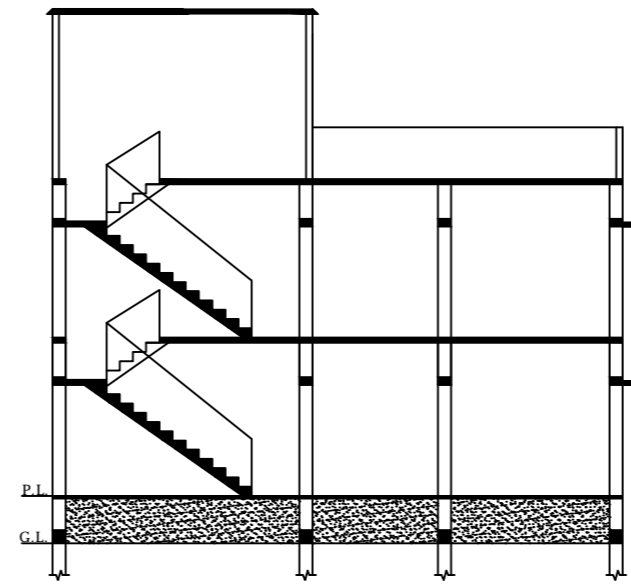

SECTION- XX

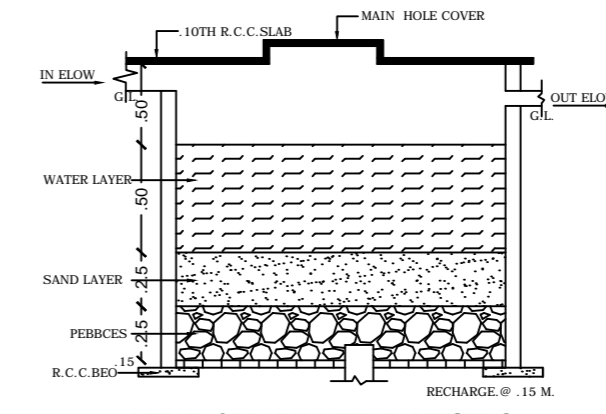

DETAIL OF RAIN WATER HARVESTING AND RECHARGE PIT. (N.T.S)

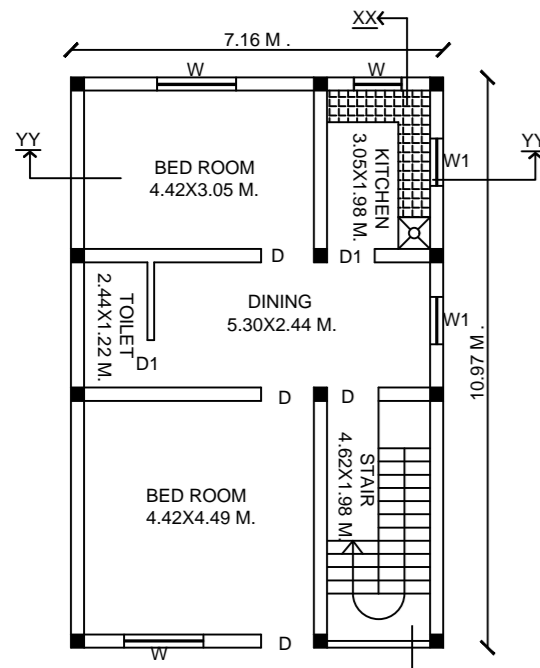

PROPOSED GROUND FLOOR PLAN

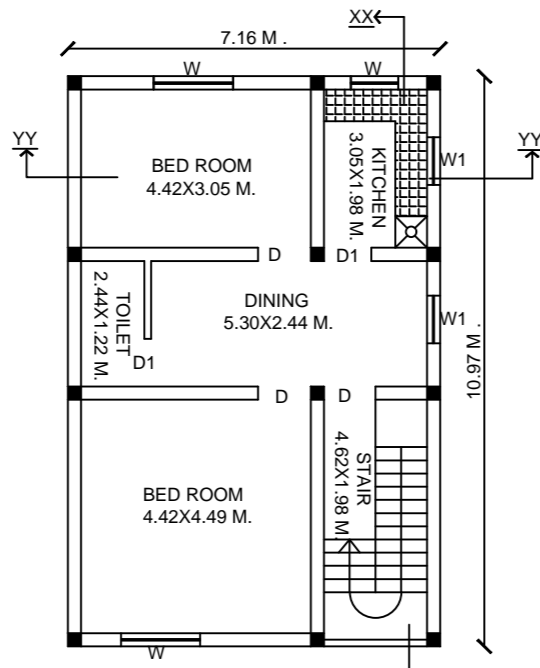

PROPOSED FIRST FLOOR PLAN

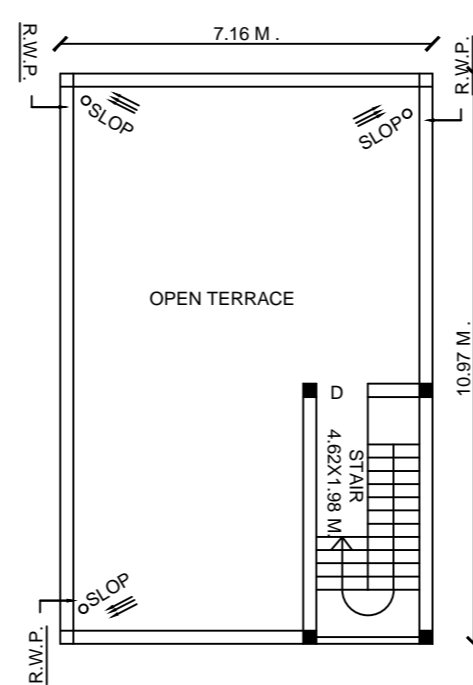

TERRACE FLOOR PLAN

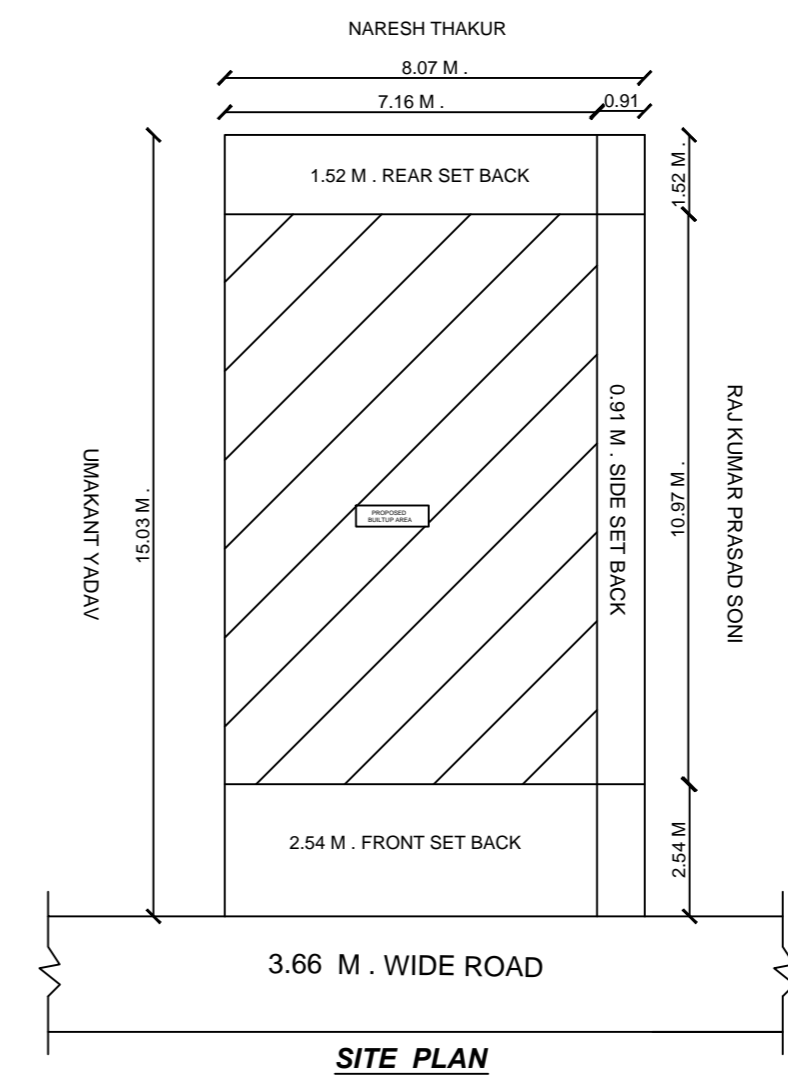

SITE PLAN

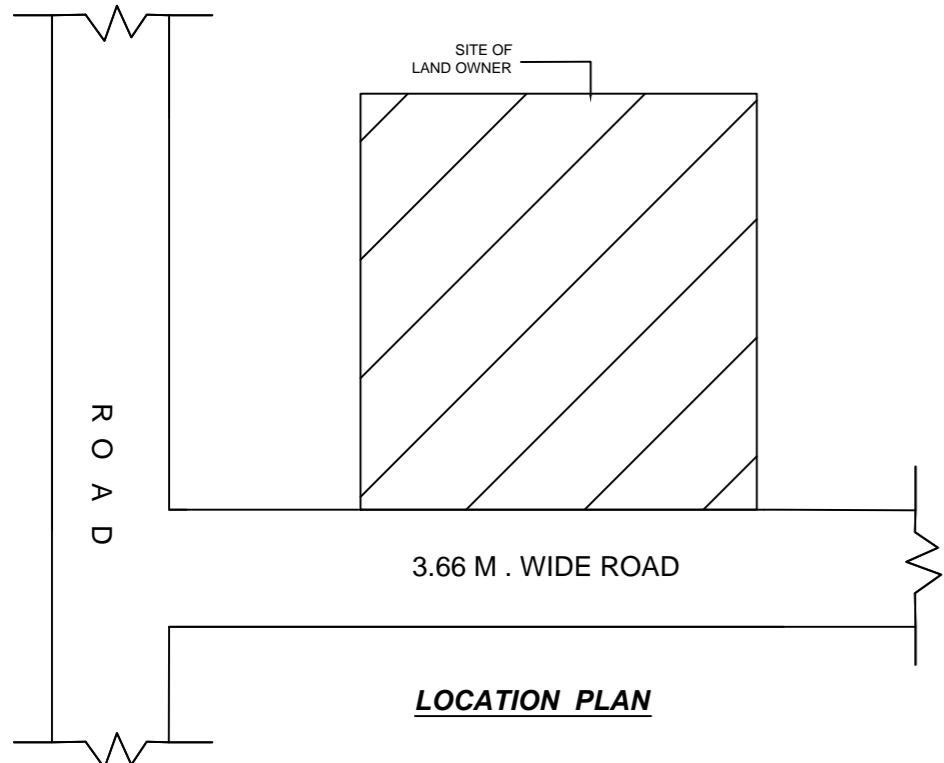

LOCATION PLAN

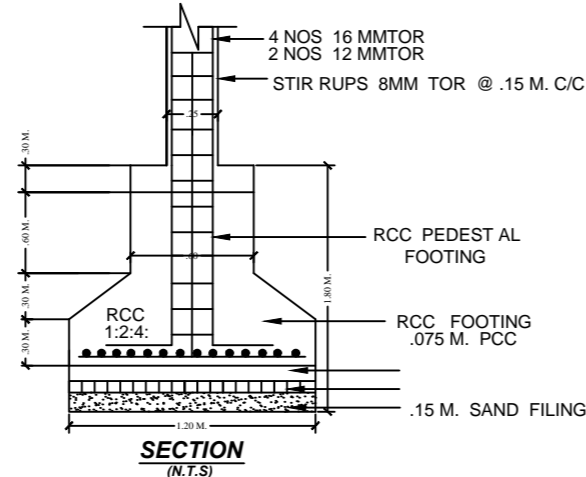

SECTION (N.T.S)

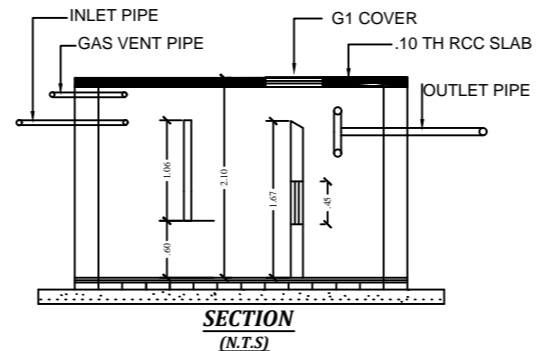

SECTION (N.T.S)

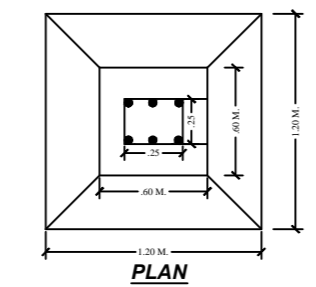

PLAN

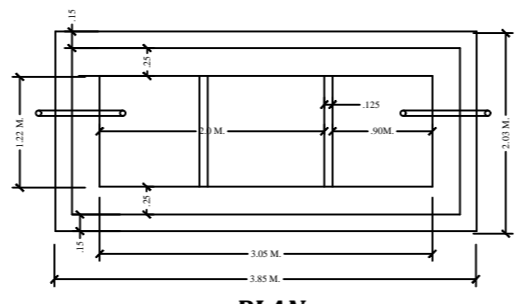

PLAN
DETAIL OF SEPTIC TANK

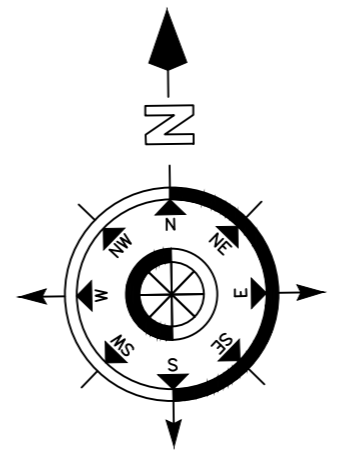

MAP APPROVED BY

SCHEDULE OF DS & WS

TYPE	SIZE	REMARKS
D	1.06 M.X2.10 M.	F PANELED
D1	0.06 M.X2.10 M.	F PANELED
D2	0.75 M.X2.10 M.	F PANELED
W	1.50 M.X1.20 M.	F GLAZZED
W1	1.20 M.X1.20 M.	F GLAZZED
W2	0.91 M.X1.20 M.	F GLAZZED
C.GATE	2.10 M.X2.10 M.	IRON

SPECIFICATION

- DETAIL OF R.C.C. FOOTING COLUMN FON (M.25)
- 1ST CLASS BRICK WORK IN CEMENT PLASTER (1:6)
- 1.25X.15TH. R.C.C. LINTEL BAND OVER DOOR'S & WINDOW'S
- .10TH. LIME CON. TERR.OVER .10TH. R.C.C. ROOF SLAB(M.25)
- SAL WOOD FRAME & SUAM WOOD SHUTTER.
- 0.012TH. IN CEMENT PLASTER IN BOTH SIDE WACC (1:6)
- MARBLE OR MOSAIC FLOORING OVER .110TH. DRY RAMMED KHOA OVER B.F. SOILING , OVER LOCAL SAND FILLING .
- 2 CUAT OF WHITE & COLOUR WASH AS PER CHOICE.
- 17CM.WIDE & 30 CM. PUCCA DRAIN AROUND THE BUILDING .

TOTAL PLOT AREA	=	121.29	SQM.
NET PLOT AREA	=	121.29	SQM.
TOTAL OPEN LAND AREA	=	42.75	SQM.
PROPOSED GROUND FLOOR B/A	=	78.54	SQM.
PROPOSED FIRST FLOOR B/A	=	78.54	SQM.
TOTAL B/A	=	157.08	SQM.
F.A.R.	=	1.29	
% OF COVERED AREA	=	64 %	
BUILDING HEIGHT	=	7.00 M.	

PROPOSED RESIDENTIAL BUILDING OF
 NAME- POONAM KUMARI
 W/O. - SRI INDRA KUMAR JAISWAL
 MAUZA- LATEHAR
 P.S. - LATEHAR
 P.S. NO.- 250
 WARD NO.- 05
 KHATA NO.- 84
 PLOT NO.- 116
 HOLDING NO.-
 TOUZI NO.- 51
 DIST. - LATEHAR (JHARKHAND)

SIGNATURE OF APPLICANT

SIGNATURE OF ENGINEER