

FRONT ELEVATION

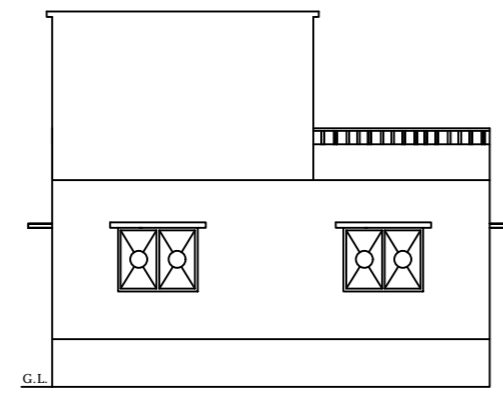

EAST SIDE ELEVATION

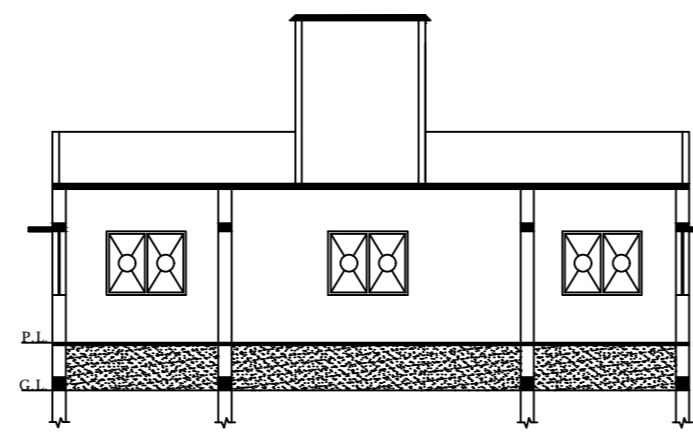

SECTION-YY

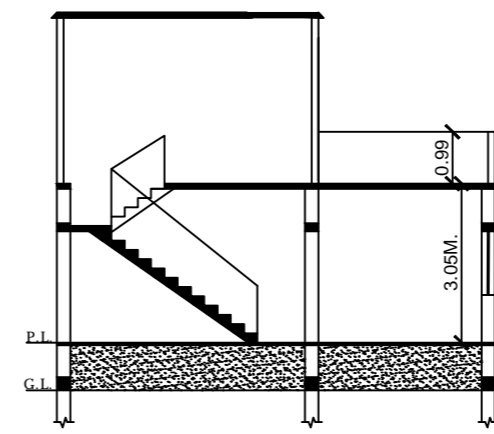

SECTION-XX

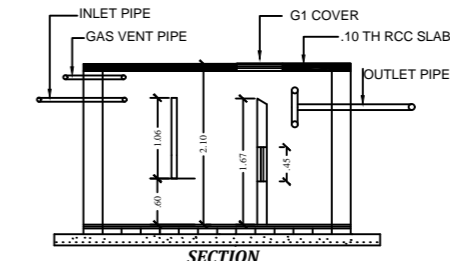

SECTION (N.T.S)

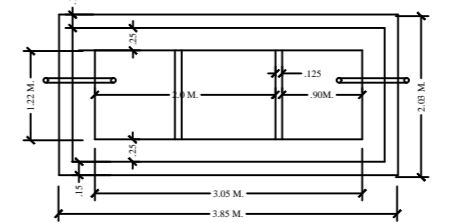

PLAN
DETAIL OF SEPTIC TANK

SCHEDULE OF DS & WS

TYPE	SIZE	REMARKS
D	1.06 M.X2.10 M.	F PANELED
D1	0.06 M.X2.10 M.	F PANELED
D2	0.75 M.X2.10 M.	F PANELED
W	1.50 M.X1.20 M.	F GLAZZED
W1	1.20 M.X1.20 M.	F GLAZZED
W2	0.91 M.X1.20 M.	F GLAZZED
C.GATE	2.10 M.X2.10 M.	IRON

SPECIFICATION

- 1 DETAIL OF R.C.C. FOOTING COLUMN FON (M.25)
- 2 1ST CLASS BRICK WORK IN CEMENT PLASTER (1:6)
- 3 1.25X.15TH. R.C.C. LINTEL BAND OVER DOOR'S & WINDOW'S
- 4 10TH. LIME CON. TERR.OVER .10TH. R.C.C. ROOF SLAB(M.25)
- 5 SAL WOOD FRAME & SUAM WOOD SHUTTER.
- 6 0.012TH. IN CEMENT PLASTER IN BOTH SIDE WACC (1:6)
- 7 MARBLE OR MOSAIC FLOORING OVER .110TH. DRY RAMMED KHOA OVER B.F. SOILING . OVER LOCAL SAND FILLING .
- 8 2 CUAT OF WHITE & COLOUR WASH AS PER CHOICE.
- 9 17CM.WIDE & 30 CM. PUCCA DRAIN AROUND THE BUILDING .

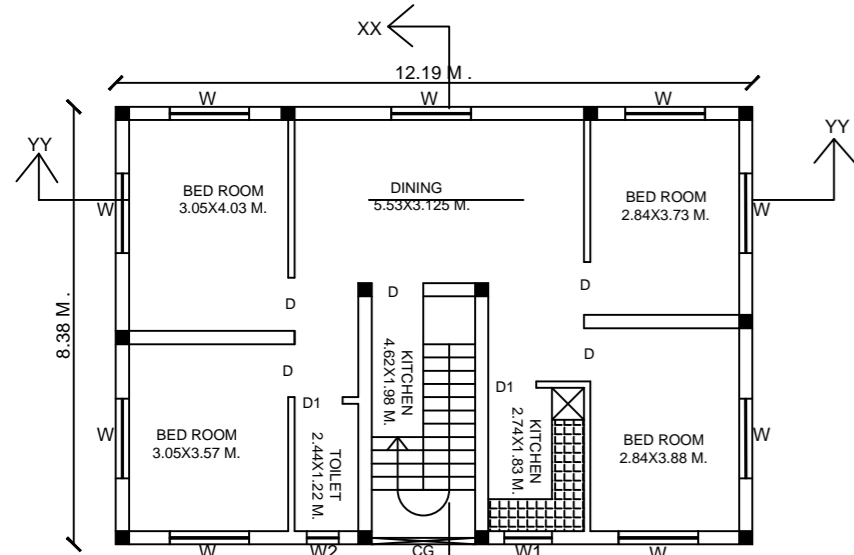

PROPOSED GROUND FLOOR PLAN

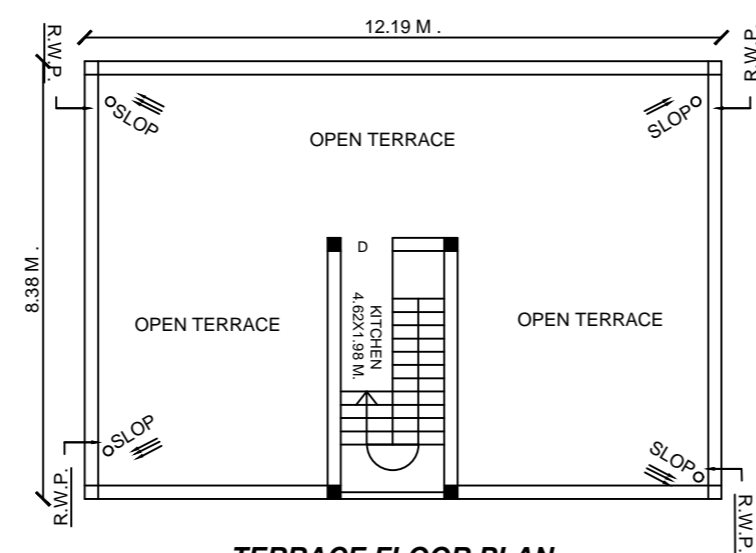

TERRACE FLOOR PLAN

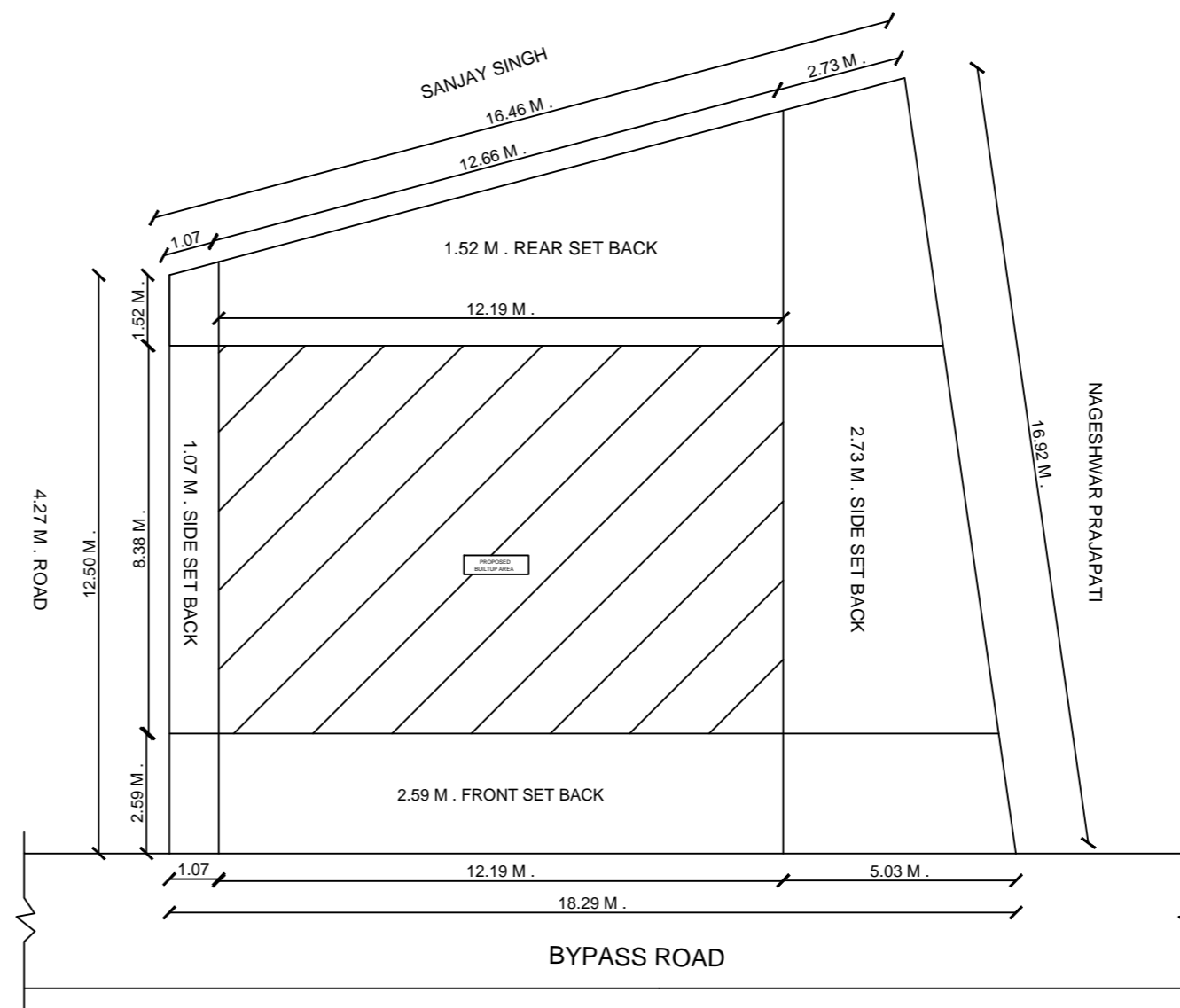

SITE PLAN

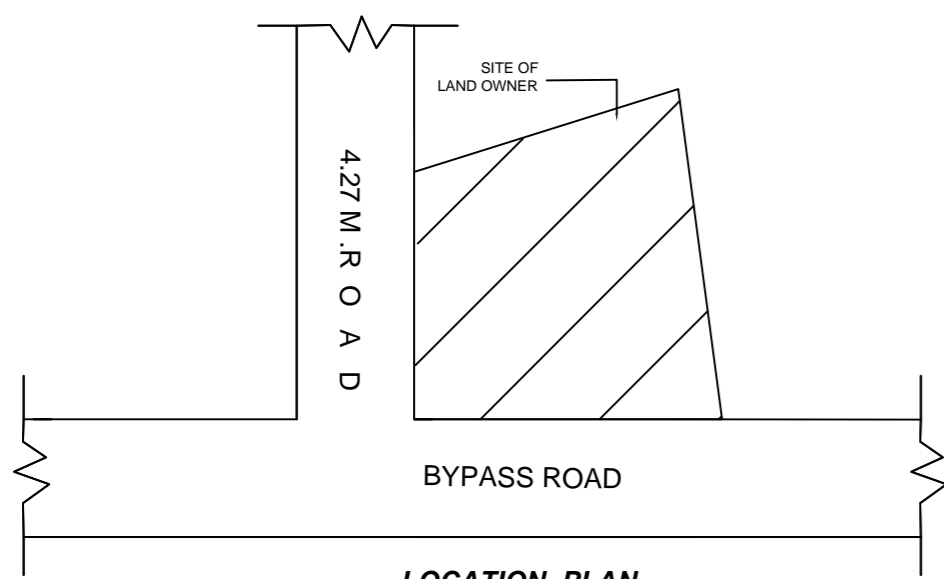

LOCATION PLAN

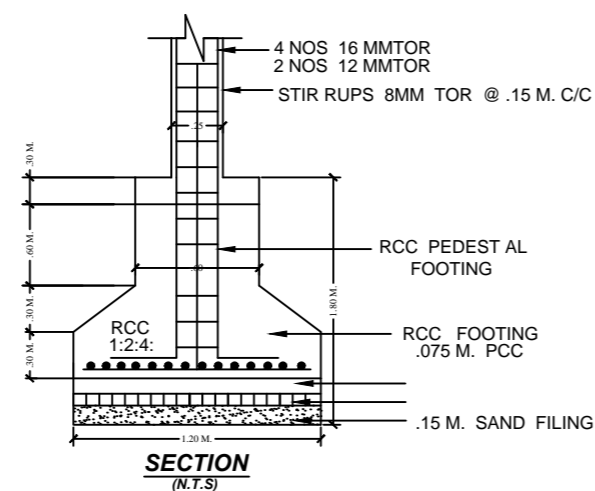

SECTION (N.T.S)

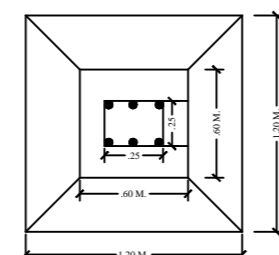

PLAN

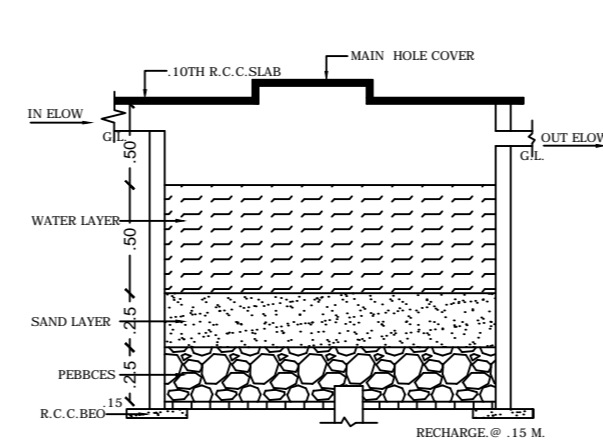

DETAIL OF RAIN WATER HARVESTING AND RECHARGE PIT.(N.T.S)

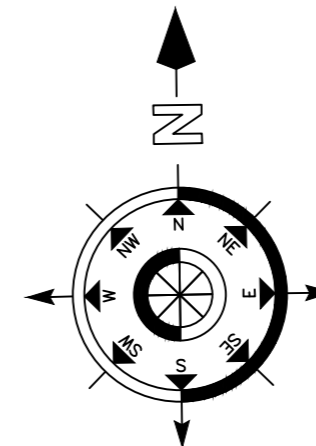

MAP APPROVED BY

SIGNATURE OF APPLICANT

SIGNATURE OF ENGINEER

TOTAL PLOT AREA	=	252.55	SQM.
NET PLOT AREA	=	252.55	SQM.
TOTAL OPEN LAND AREA	=	150.44	SQM.
GROUND FLOOR B/A	=	102.15	SQM.
TOTAL B/A	=	102.15	SQM.
F.A.R.	=	0.40	
% OF COVRED AREA	=	40 %	
BUILDING HEIGHT	=	3.96 M.	

PROPOSED RESIDENTIAL BUILDING OF
 NAME- SRI PRABHU PRAJAPATI
 S/O - SRI NAGESHWAR PRAJAPATI
 MAUZA- TAPAKHAS
 P.S. - LATEHAR
 P.S. NO.- 249
 WARD NO.- 02
 KHATA NO.- 16
 PLOT NO.- 317, 418
 H.NO.-
 TOUZI NO.- 51
 DIST - LATEHAR (JHARKHAND)