

SECTION AT 1-1'
SCALE -1:25

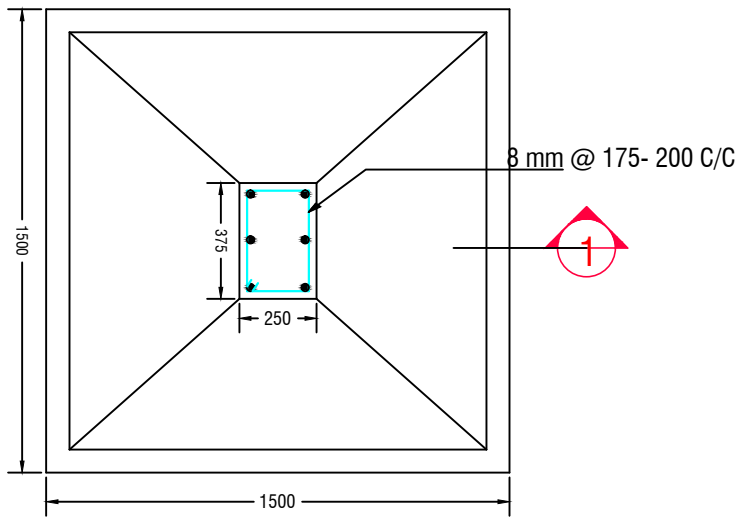

6 Nos.- 16 mm Dia Bar
TYPICAL FOUNDATION
SCALE -1:25