

NOTE:-

1. Read this drawing along with architectural & structural drawings.
2. Do not scale follow written dimensions only. All dimension are in foot unless otherwise noted.
3. All dimensions & levels shall be checked & co-related with relevant architectural & structural drawing & in case of any ambiguity the matter shall be brought to the notice of the consultant before starting the work.
4. Grade of concrete shall be **M-20** & shall be conforming to IS-456-2000.
5. Reinforcement steel shall be High Strength Deformed TMT bars as per IS-1786-1985 and having a minimum yield strength of **500 N/mm²** and having elongation more than 14.5%.
6. Clear cover to main reinforcement shall be 50 mm for footing, 40 mm for column, 25 mm for Beam and 20 mm for slab. Side cover of footing shall be 75mm.
7. Not more than 50% of bars shall be lapped at any section.
8. Lap length shall be equal to $L_d = 57$ times smaller Dia of bars and shall be avoided in following cases - Top bars - near support, Bottom bars - near midspan.
9. Wherever necessary chairs shall be provided to support the top reinforcement in position.
10. All concrete shall be machine mixed and machine vibrated.
11. Sufficient concrete cube test and steel yield strength test is to be performed for different batches & report shall be submitted to proper authority.
12. Use 10% extra cement in concrete for casting under the water table.
13. Bearing Capacity of the soil is below Ground level as per given by client.
14. Foundation has been designed for **(G + 2)** structure only
15. L_d means 57 times of dia of bars.
16. Structure is designed for earthquake zone IV
17. For any ambiguity, discrepancy, deficient provision (if any felt necessary) etc must be brought to the notice of consultant/design office for clarification and work must be carried out after obtaining approval from competent authority.

KHAATA NO:- 226
 PLOT NO :- 5016
 AREA :- 5.5 DECIMAL
 THANNA NO:- SIMDEGA
 MOUZA :- GOTRA
 BOUNDARY:-
 NORTH:- PCC 12'
 SOUTH:- ANUP SIHISTAV LAND
 EAST:- KRISHNA PRASAD LAND
 WEST:- SANT PRASAD LAND

CLIENT:- PRADEEP PRASAD
 S/O:- LATE GANDURA PRASAD

NAME OF PROJECT :- Residential HOUSE PLAN

TITLE :- Submission plan

SHEET NO :-01 | SIMDEGA

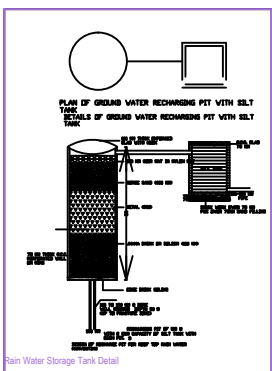
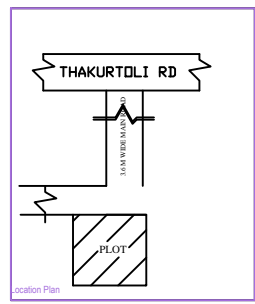
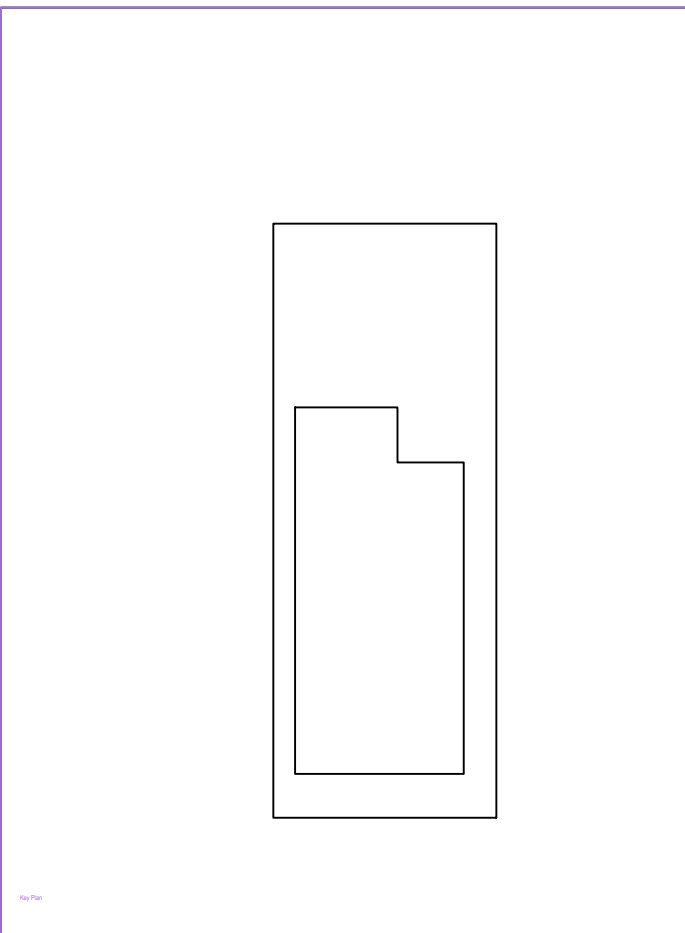
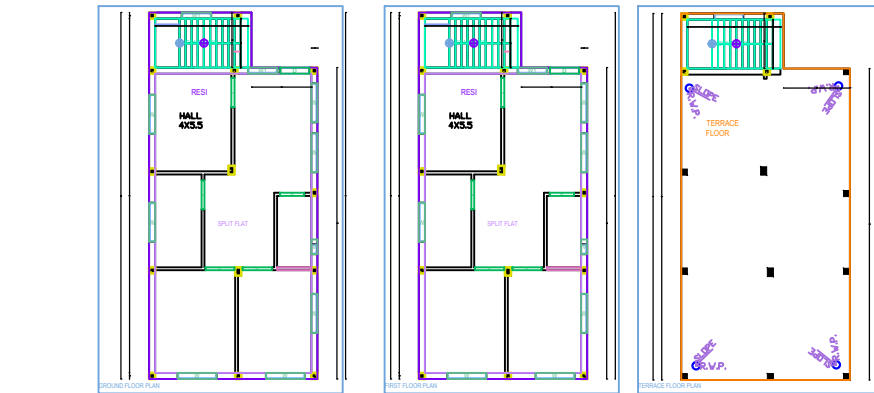
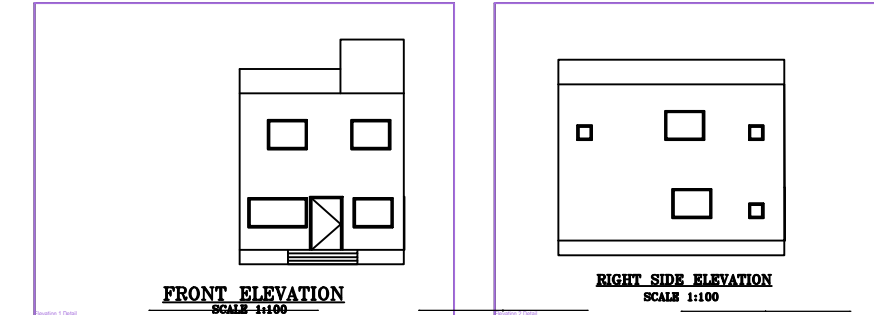
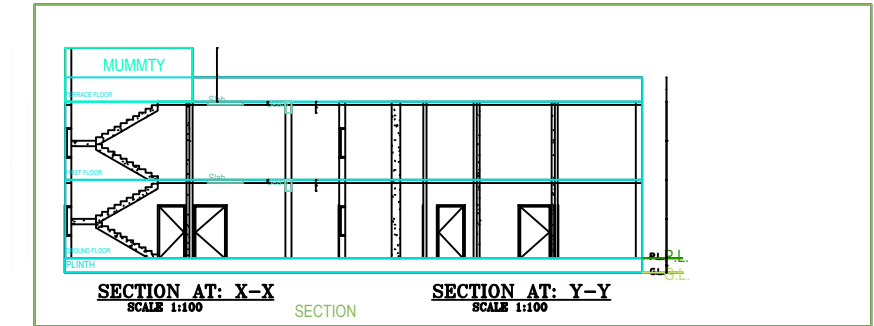
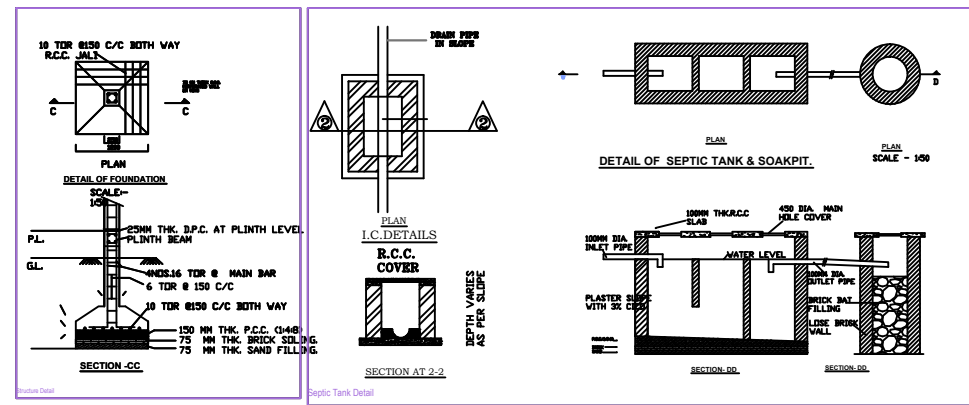

SPECIFICATIONS

1. BRICKWORK IN FOUNDATION & PLINTH SHALL BE OF FIRST CLASS BRICK IN CEMENT MORTAR 1:6 AND HALF BRICK WILL BE 1:4 CEMENT MORTAR
2. MASONRY FOUNDATION WITH ISOLATED R.C.C COLUMN SHALL BE PROVIDED WITH CURTAIN GLAZING/ STRUCTURAL GLAZING OF GOOD QUALITY AND VENTILATOR SYSTEM SHALL BE USED
3. CURTAIN GLAZING/ STRUCTURAL GLAZING OF GOOD QUALITY AND VENTILATOR SYSTEM SHALL BE USED
4. ROLLING SHUTTER SHALL BE USED FOR SHOPS OPENINGS
5. M.S GLAZED/ANODIZED ALUMINIUM/NCL SECCOLOR WINDOW AND R.C.C WITH CEMENT MORTAR 1:4
6. ALL R.C.C WORKS SHALL BE DONE IN 1:1.5:(M20) MIX CONCRETE TMT STEEL BARS (OFE, 500) SHALL BE USED IN R.C.C STRUCTURES COMMERCIAL QUALITY
7. ALL MASONRY SURFACE SHALL BE PLASTERED WITH CEMENT MORTAR OVER R.C.C SLAB / P.C.C
8. ALL STEEL AND WOOD WORK SHALL BE PAINTED WITH SYNTHETIC PAINT WORKMANSHIP
9. ALL SANITARY AND ELECTRICAL FITTINGS SHALL BE OF STANDARD MARK
10. KOTTA STONE / MOSAIC FLOORING INCLUDING STAIRCASE SHALL BE USED

SL.NO.	SCHEDULE OF OPENINGS	SIZE	DESCRIPTION
1.	D	1.1X2.10	Sal wood chaukhat & Gamhar wood shutter
2.	D1	.90X2.10	Sal wood chaukhat & Gamhar wood shutter
3.	D2	.75X2.10	Sal wood chaukhat & Gamhar wood shutter
4.	W	1.50X1.20	Fully glazed window
5.	W1	1.20X1.20	Fully glazed window
6.	V2	.90X1.20	Fully glazed window
7.	V	.60X.60	CELLING VANTILOTER
8.	C.G	2.10X2.10	

SCHEDULE OF AREA	
1. TOTAL PLOT AREA AS PER SITE	: 222.38 SQM
2. PROPOSED AREA AT GROUND FLOOR	: 97.41 SQM
3. TOTAL BUILD UP AREA	: 97.41 SQM
4. COVERED AREA	: 97.41X100 = 43.80% 222.38

PROPOSED RESIDENTIAL BUILDING FOR
 MR PRADEEP PRASAD
 S/O - LATE GANDURA PRASAD
 KHATA NO - 226 , PLOT NO -5016.
 RAKWA - 5.5 DISMIL.
 THANNA NO - 80.
 MOHALLA - SAMTOLI
 MAUZA - GOTRA.
 DISTT. - SIMDEGA (JHARKHAND)

R.S CONSULTANT
 SONAR TOLI ,NEAR SAMLESHWARI TVS
 MAIN ROAD SIMDEGA JHARKHAND
 MOBILE - 7008039097

SCALE - 1:100

AS MENTIONED	SH.NO.
1/1	

SIGNATURE OF I.C. ENGINEER
 NAGAR PARSAD SIMDEGA

SIGNATURE OF OWNER

Floor Name	Total Built Up Area (Sq.mt)	Proposed Floor Area (Sq.mt)	Total FAR Area (Sq.mt)	Tent (No.)
Ground Floor	114.20	114.20	114.20	01
First Floor	114.20	114.20	114.20	01
Terrace Floor	6.00	6.00	6.00	00
Total	234.40	234.40	234.40	02
Total Number of Store Buildings	1			