

Project Title: SMT ANJURAJUK

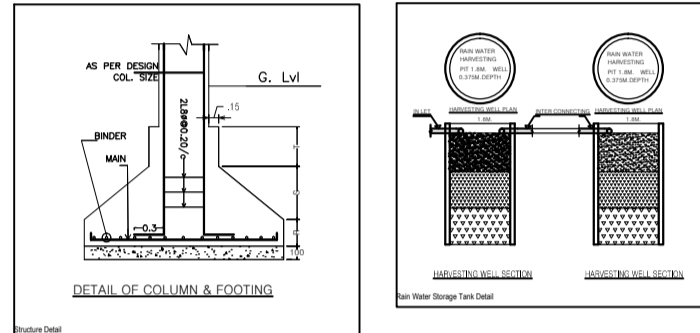

Area	Existing	Proposed	Total
1. PLOT AREA	414.64 Sqm	414.64 Sqm	414.64 Sqm
2. BUILDING FOOTPRINT	0.00 Sqm	45.15 Sqm	45.15 Sqm
3. OPEN SPACE	414.64 Sqm	0.00 Sqm	414.64 Sqm
4. TOTAL	414.64 Sqm	45.15 Sqm	459.79 Sqm

NOTE:
1. ALL DIMENSIONS IN METERS.
2. DIMENSIONS NOT TO BE SCALE.

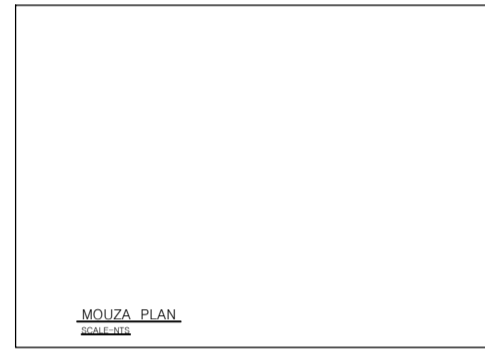
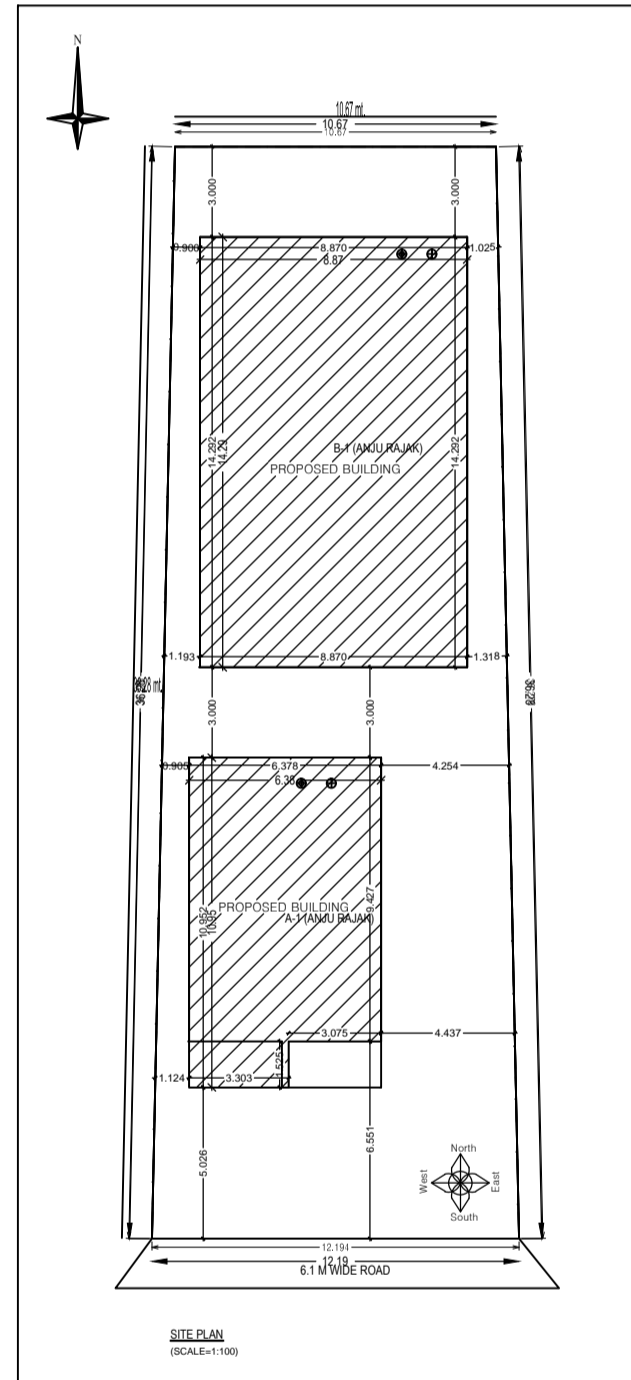
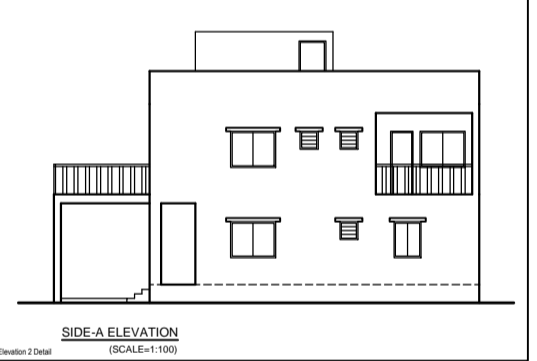
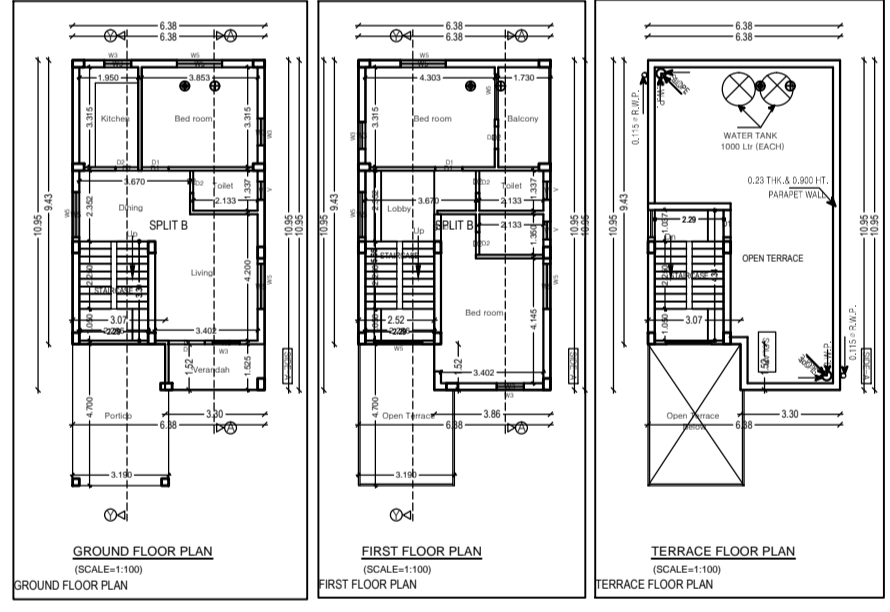
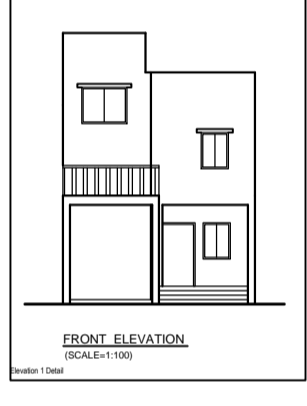
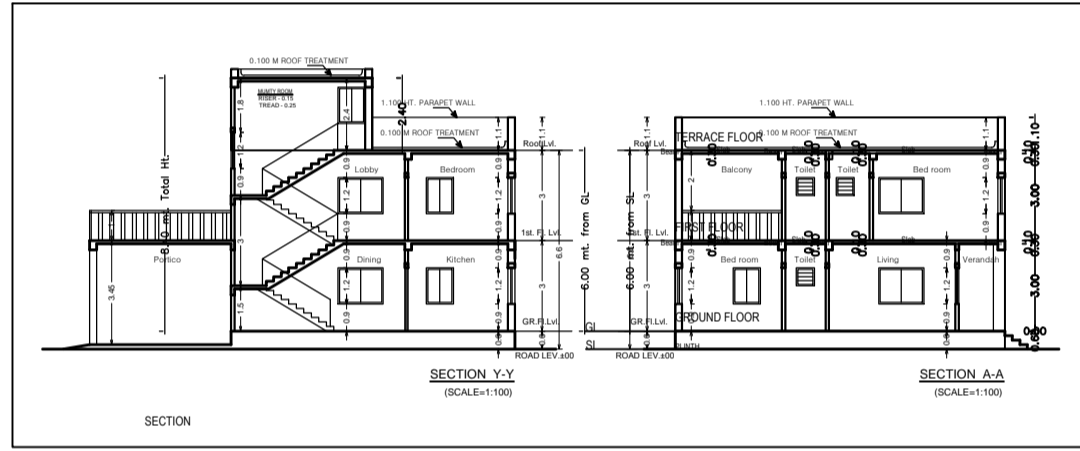

OWNER / POAH

Signature of Applicant:
L.X. BURMAN
Reg No: 0401002
Date: 12/01/2016
Reg No: 0401002/2016

Project Title: SMT ANJURAJUK

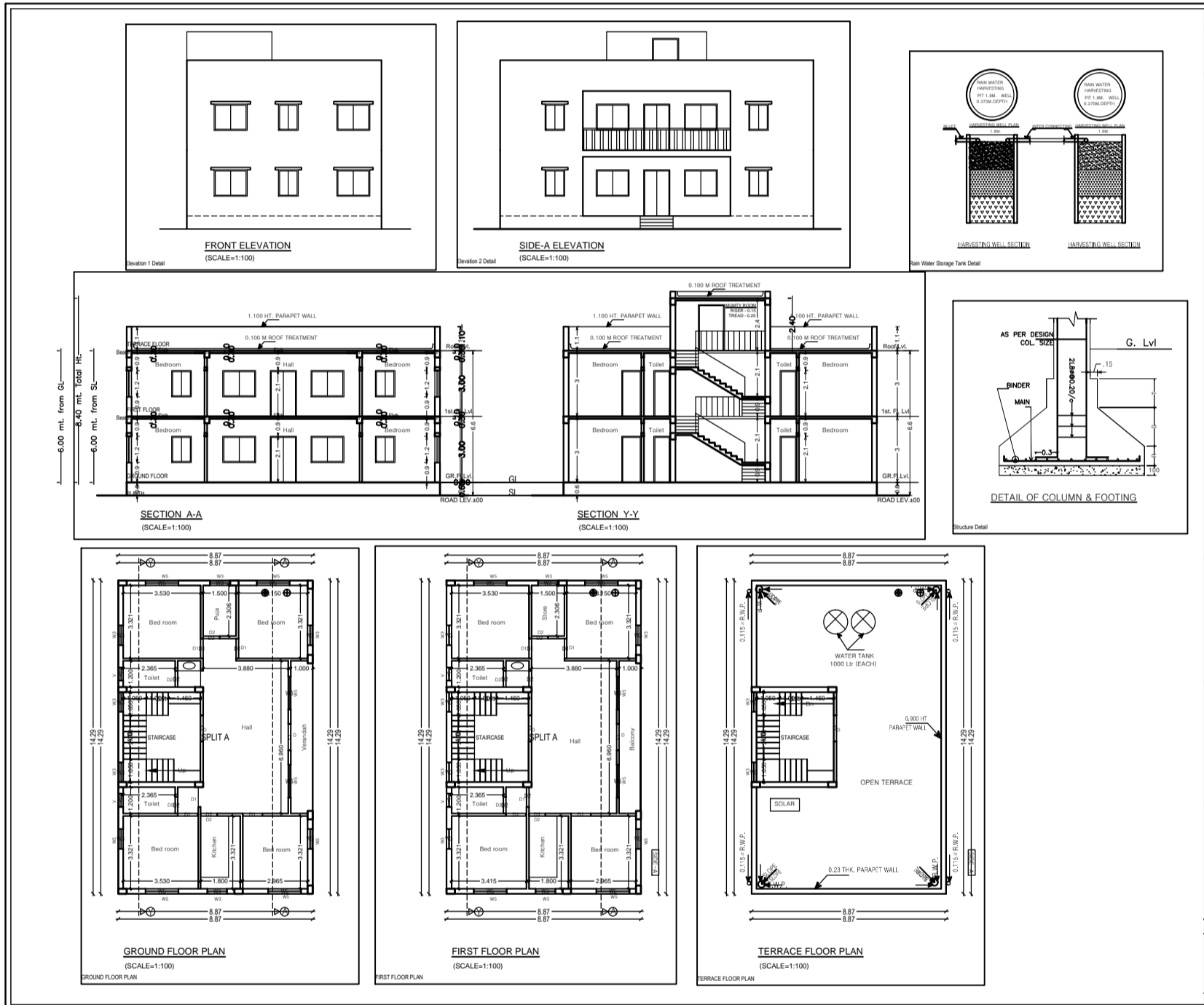

OWNER / POAH

Signature of Applicant:
L.X. BURMAN
Reg No: 0401002
Date: 12/01/2016
Reg No: 0401002/2016

Building A (ANJURAJUK)

Item	Quantity	Unit	Rate	Total
Concrete	100	m ³	100	10000
Steel	50	kg	200	10000
Brick	1000	m ²	100	100000
Labour	100	hr	100	10000
Total				130000

SCHEDULE OF JOINERY

Item	Quantity	Unit	Rate	Total
Wood	100	m ³	100	10000
Labour	100	hr	100	10000
Total				20000

UNIT PRICE Table for Building A (ANJURAJUK)

Item	Quantity	Unit	Rate	Total
Concrete	100	m ³	100	10000
Steel	50	kg	200	10000
Brick	1000	m ²	100	100000
Labour	100	hr	100	10000
Total				130000

Building B (ANJURAJUK)

Item	Quantity	Unit	Rate	Total
Concrete	150	m ³	100	15000
Steel	75	kg	200	15000
Brick	1500	m ²	100	150000
Labour	150	hr	100	15000
Total				195000

SCHEDULE OF JOINERY

Item	Quantity	Unit	Rate	Total
Wood	150	m ³	100	15000
Labour	150	hr	100	15000
Total				30000

UNIT PRICE Table for Building B (ANJURAJUK)

Item	Quantity	Unit	Rate	Total
Concrete	150	m ³	100	15000
Steel	75	kg	200	15000
Brick	1500	m ²	100	150000
Labour	150	hr	100	15000
Total				195000

PROJECT SUMMARY

Item	Quantity	Unit	Rate	Total
Concrete	100	m ³	100	10000
Steel	50	kg	200	10000
Brick	1000	m ²	100	100000
Labour	100	hr	100	10000
Total				130000

OWNER / POAH

COLOR INDEX

Color	Code
White	1
Black	2
Grey	3
Red	4
Green	5
Blue	6
Yellow	7
Pink	8
Brown	9
Orange	10
Purple	11
Cyan	12
Magenta	13
Light Blue	14
Light Green	15
Light Red	16
Light Yellow	17
Light Purple	18
Light Cyan	19
Light Magenta	20
Light Brown	21
Light Orange	22
Light Grey	23
Light Black	24
Light White	25