

Project Title -NAME-

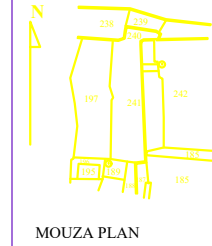

KEY PLAN

S N.B.-NEW WORK SITE SHOWN IN RED

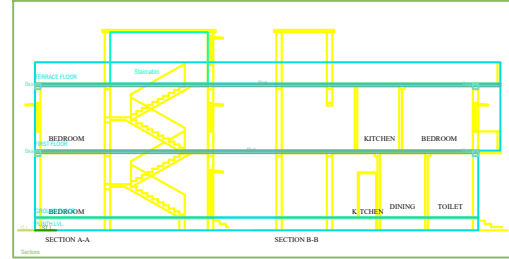
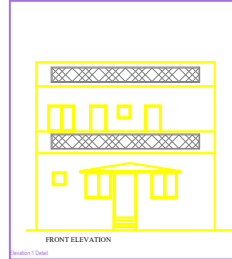
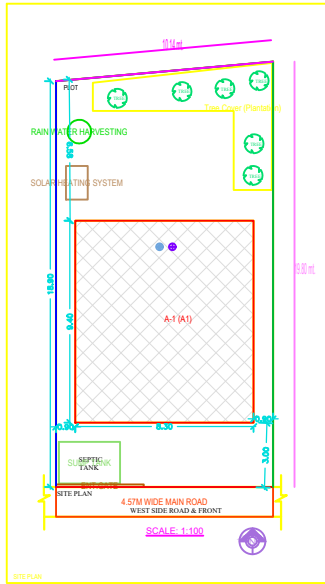
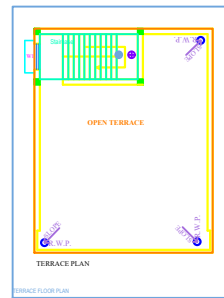
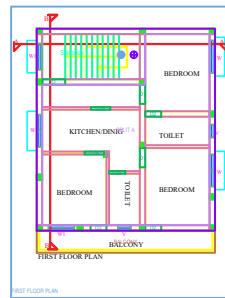
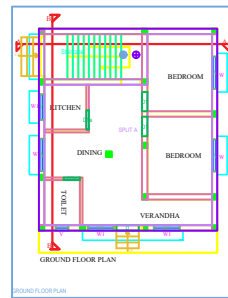

GENERAL SPECIFICATIONS:
FOUNDATION : R.C.C. column footing. Column at the beam as per design work should be as per design.
SUPERSTRUCTURE : R.C.C. column, beam & roof slab as per design should be provided unless as per grade of concrete. Lifting & reinforcement should be provided in roof slab.
INTERNAL FINISHING : Plaster in rooms, kitchen/verandha. Floor finishing in kitchen & toilet. POP in internal walls & ground floor up to 2.1 mtr in walls of toilet & kitchen.
DOORS & WINDOWS : As per schedule.
SWITCHES : PVC plate for wall socket supply & PVC plate for wall socket supply.
ELECTRIFICATION : PVC plate for socket. All electrical work should be done in accordance with the wiring & pro code book. SSB to be provided for each room. Proper body earthing must be provided.

SCHEDULE OF AREA

PLOT AREA
 BUILT UP AREA OF GROUND FLOOR
 BUILT UP AREA OF FIRST FLOOR
 TOTAL BUILT UP AREA
 COVERED AREA
 GROSS COVERED AREA
 F.A.R. ACHIEVED

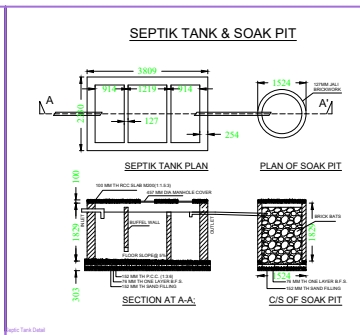
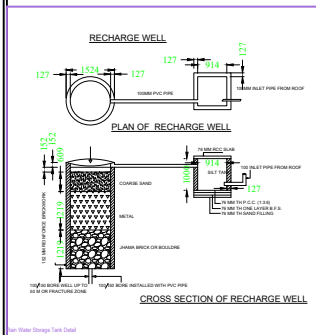

COMPASS

SCHEDULE OF OPENINGS

S.NO.	ITEM	DIMENSION	DESCRIPTION
1	D	1067 X2134	S&W wood chankani & Ready-made Flush door
2	D1	914 X2134	S&W wood chankani & Ready-made Flush door
3	D2	762 X2134	S&W wood chankani & Ready-made Flush door
4	W	1524 X1219	Fully glazed window
5	W1	1219 X1219	Fully glazed window
6	W2	914 X1219	Fully glazed window
7	V	609 X609	Ceiling Ventilator

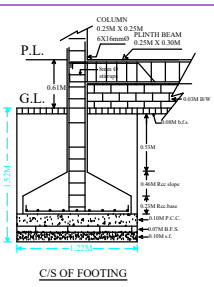
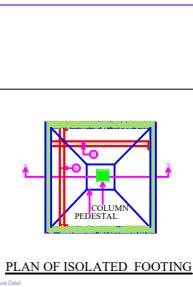

DISTRICT : SERAIKELLA-KHARSAWAN, JHARKHAND

SCALE : 1:100 AS MENTIONED IN DRAWINGS

SIGNATURE OF OWNER