

Proposal Basic Information	
Proposal File No	DMC/BP/0168/W23/2018
Owner Name	SRI YUGAL KISHOR DAS
Khata No	15
Plot No	636 (P)
Village Name	Kolokusma
Use	Residential
SubUse	Boarding

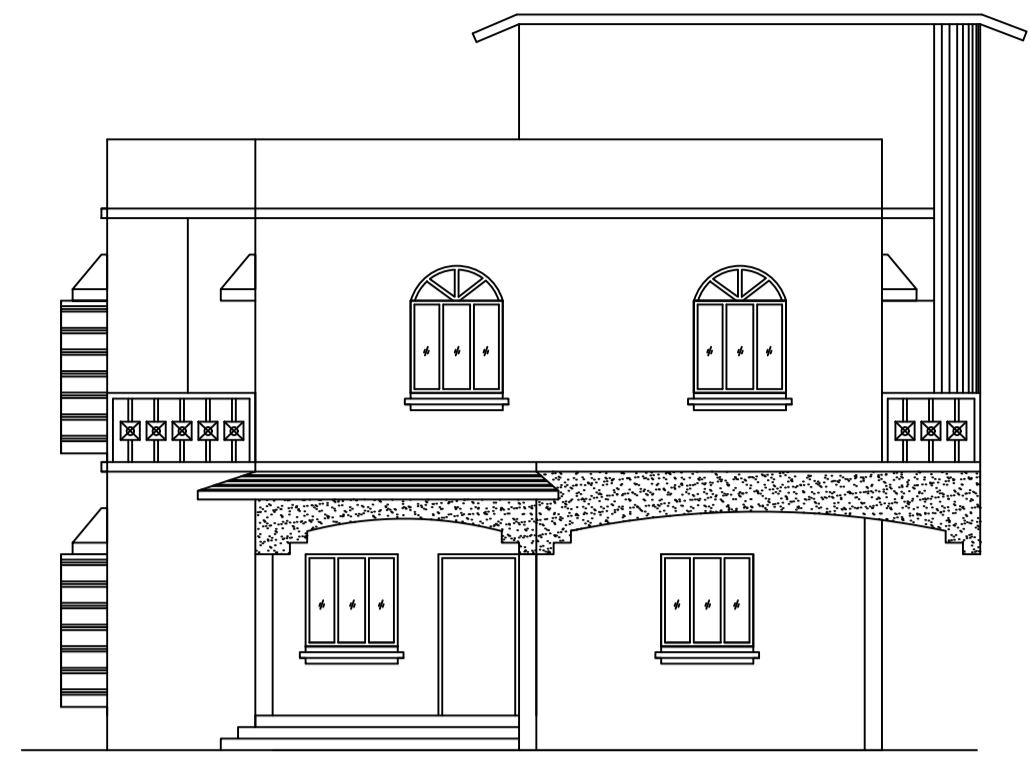

FRONT ELEVATION

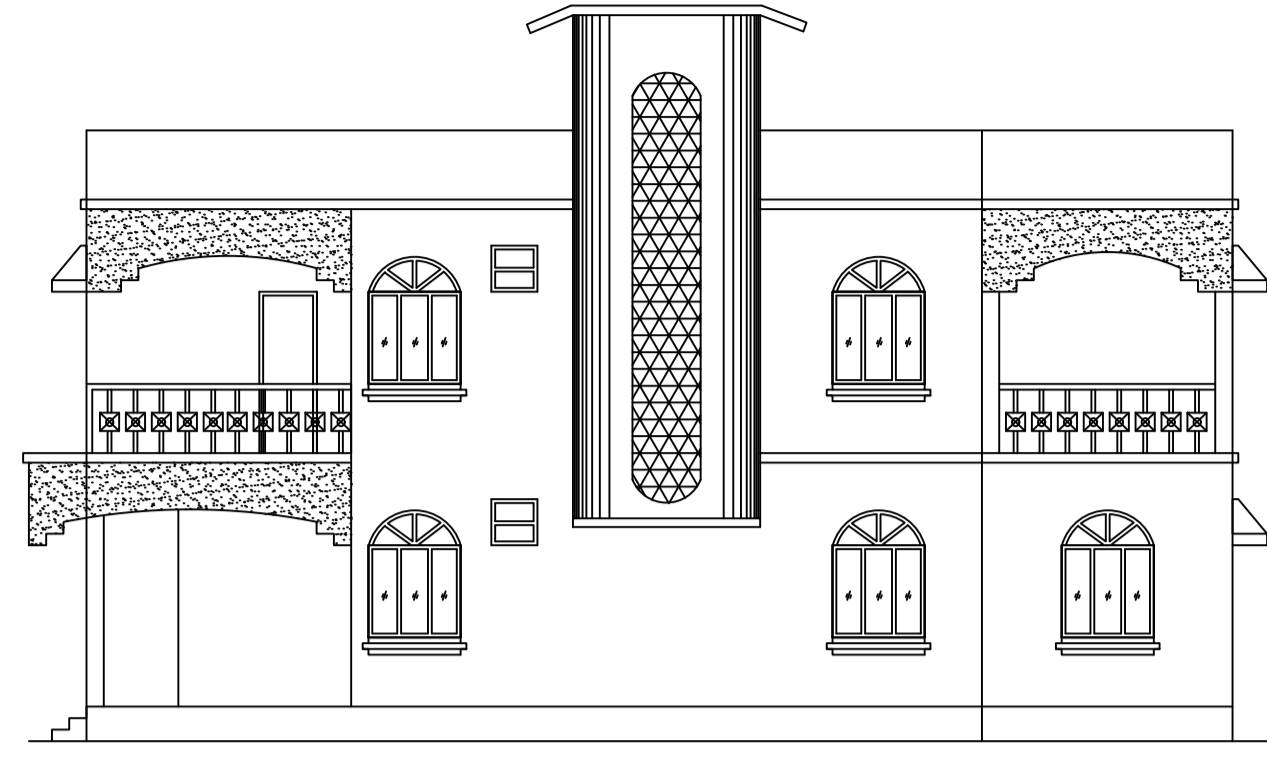

RIGHT SIDE ELEVATION

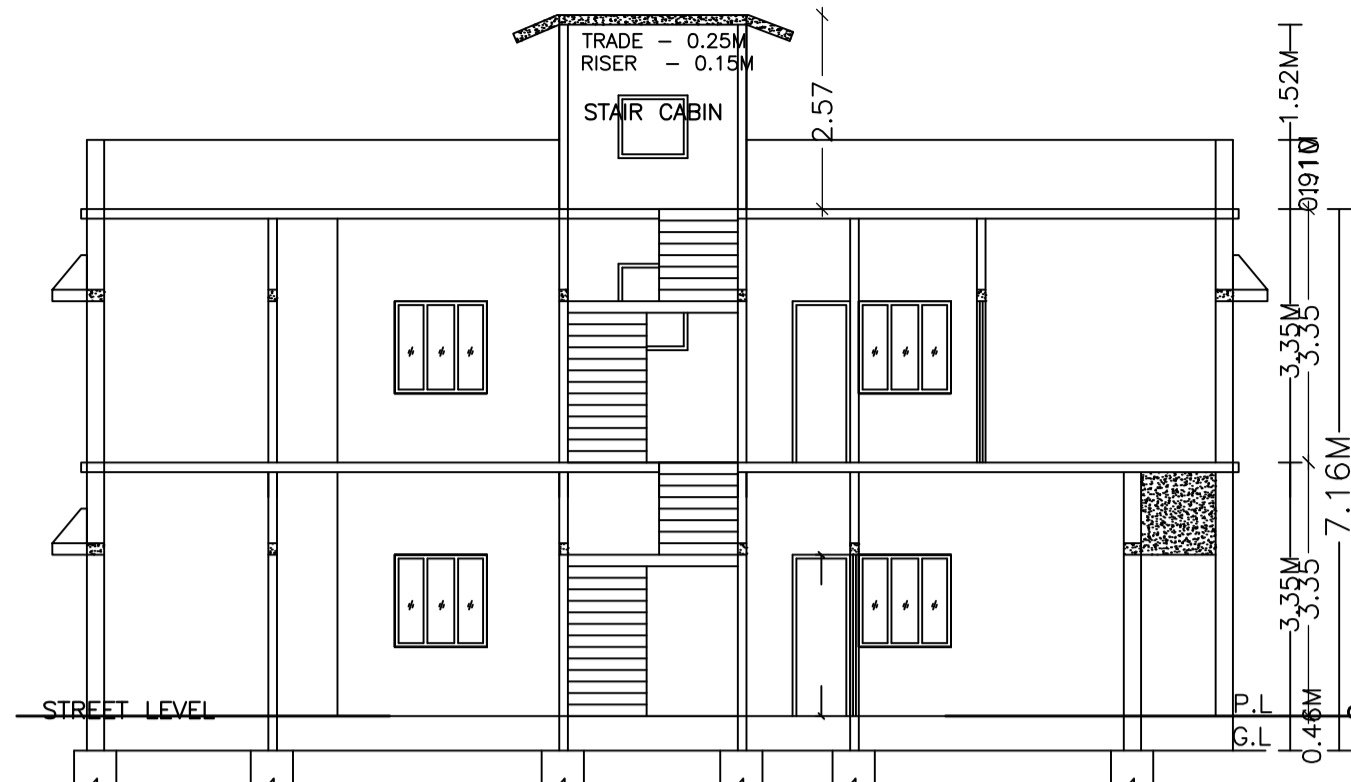

SECTION AT Y-Y

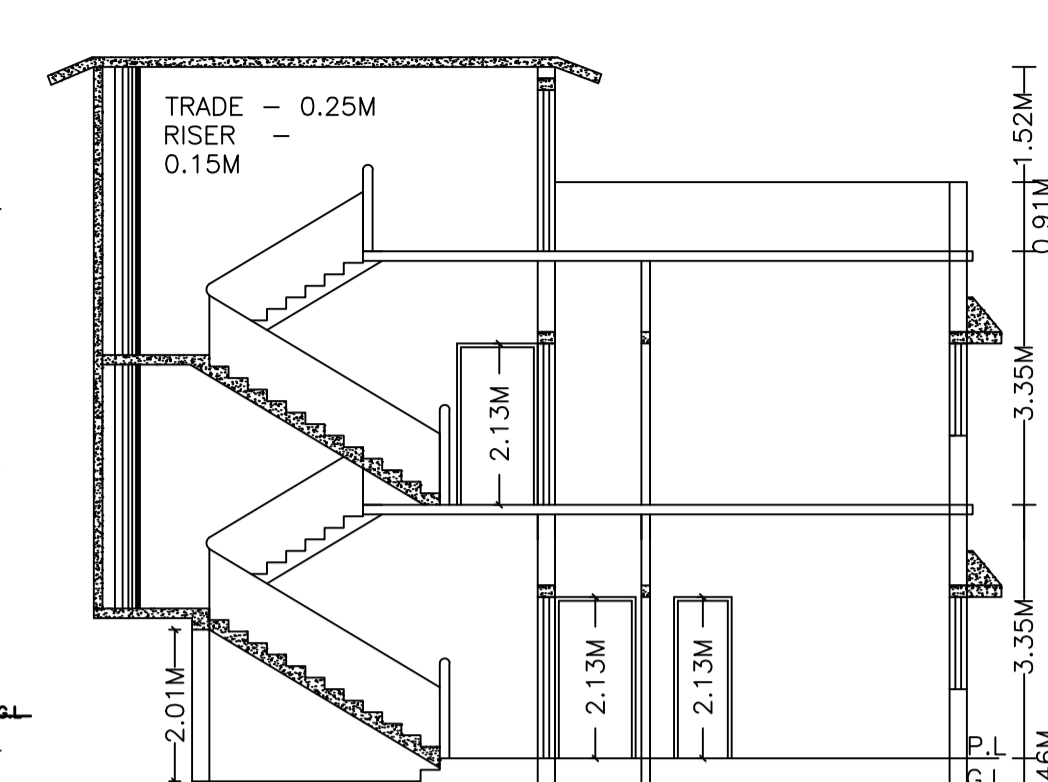

SECTION AT X-X

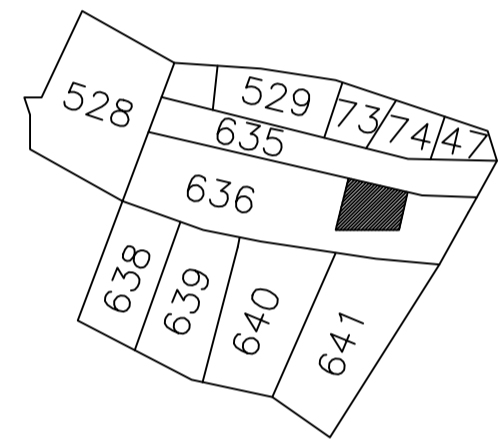

KEY- PLAN
(SCALE:- 1IN. = 330 FT.)

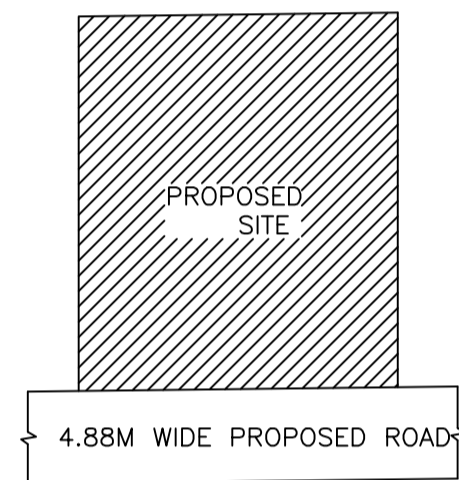

LOCATION- PLAN
(NOT TO SCALE)

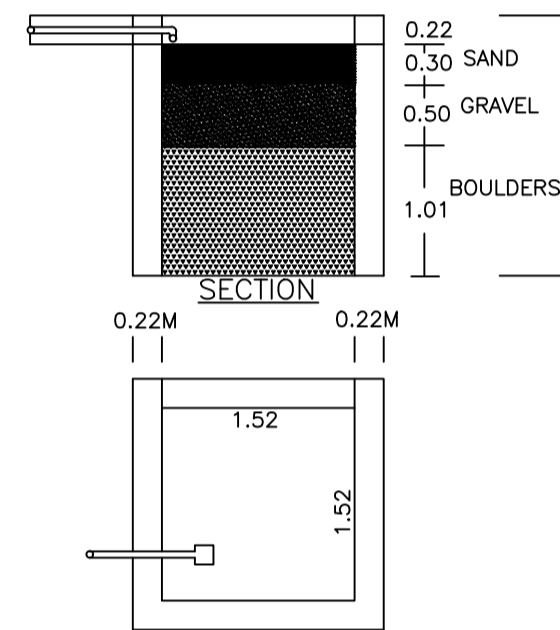

PLAN OF RAIN WATER HARVESTING
(SCALE:-1IN. = 4FT.)

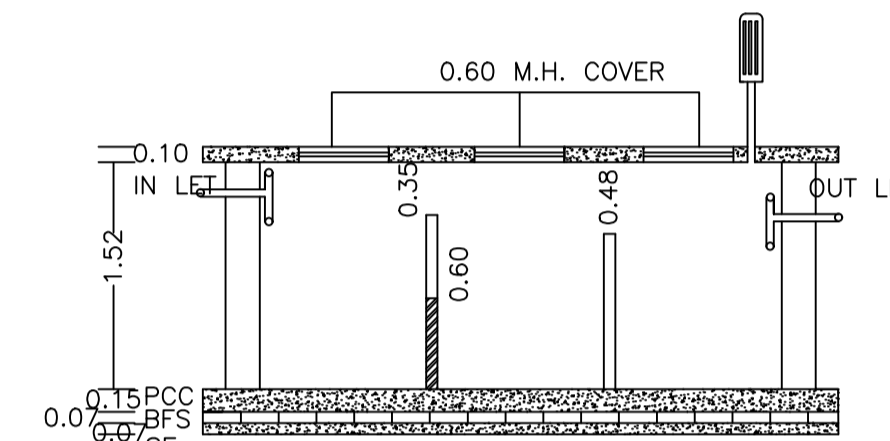

SECTION

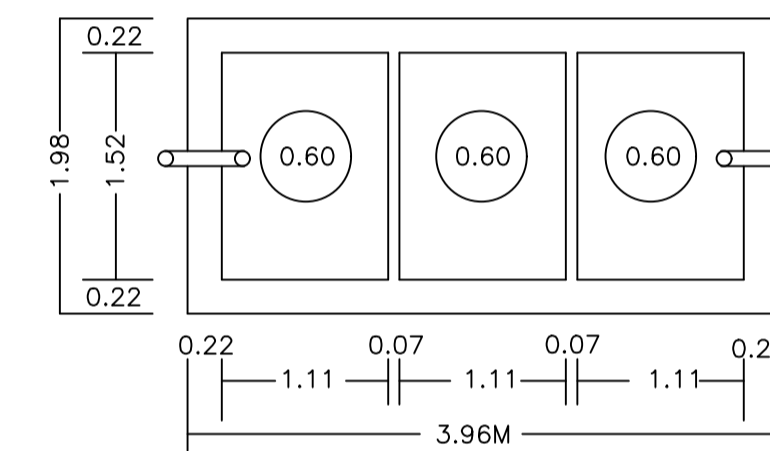

PLAN OF SEPTIC TANK
(SCALE:-1IN. = 4FT.)

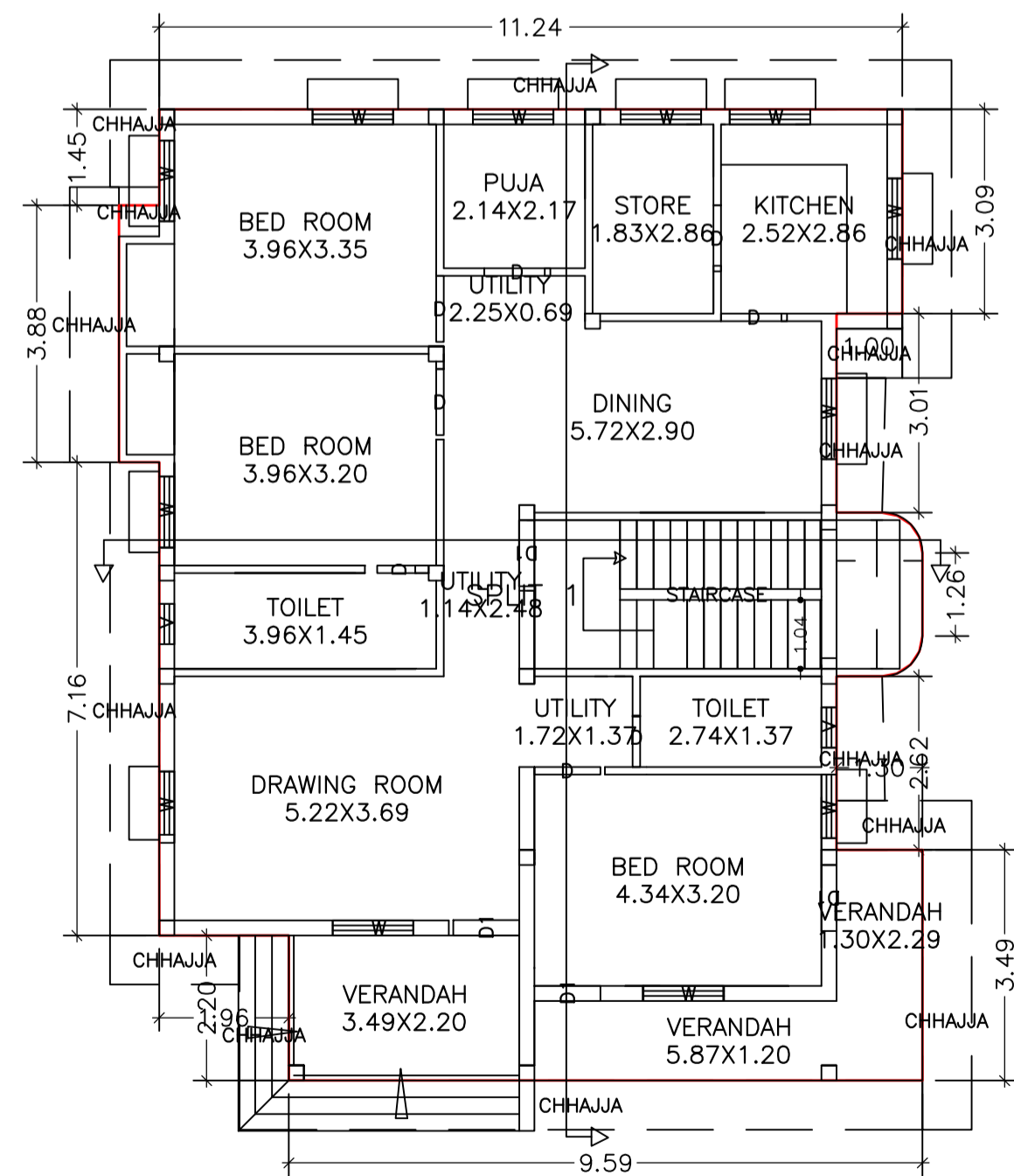

GROUND FLOOR PLAN
(Proposed)
(SCALE 1:100)

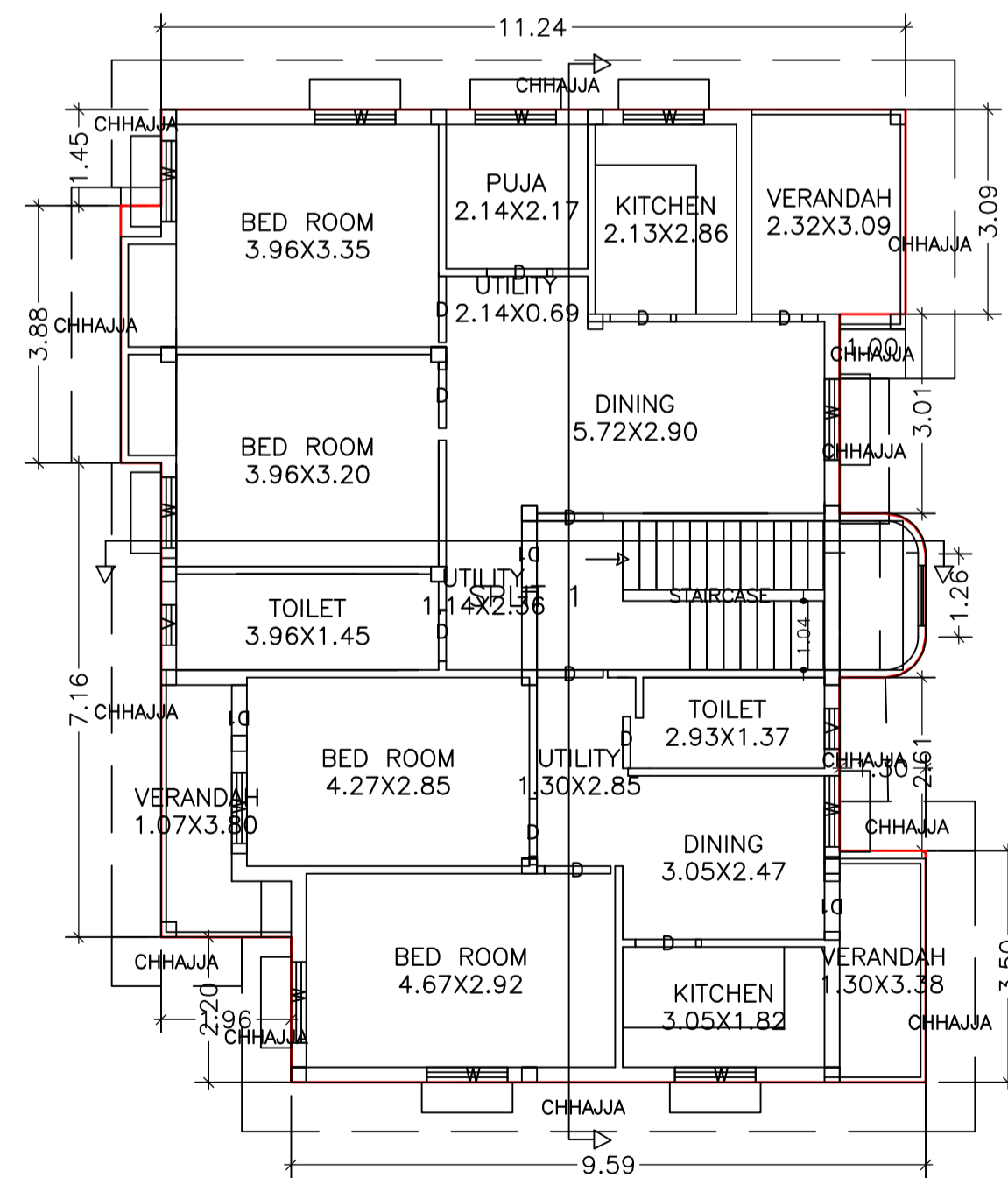

FIRST FLOOR PLAN
(Proposed)
(SCALE 1:100)

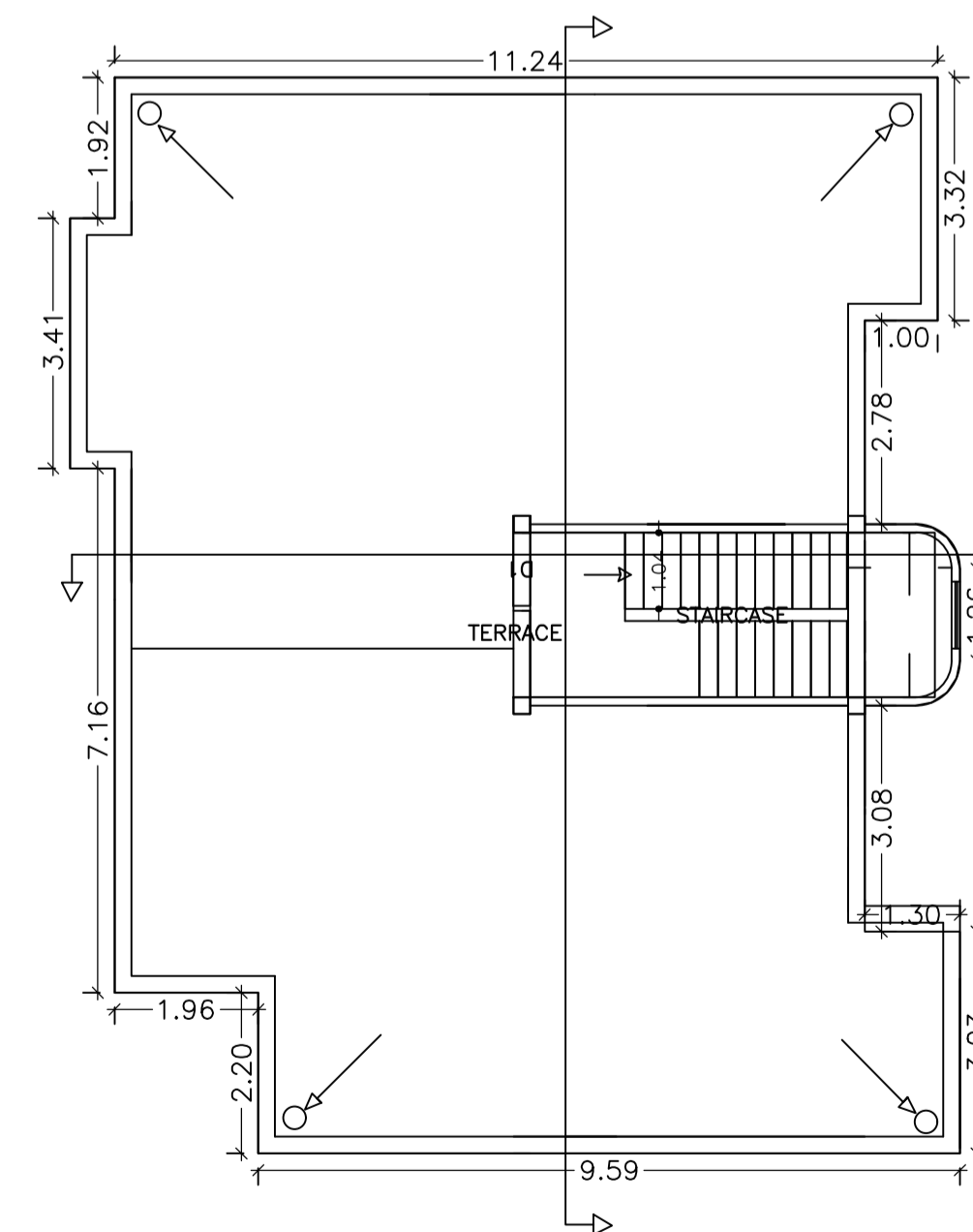

TERRACE FLOOR PLAN
(SCALE 1:100)

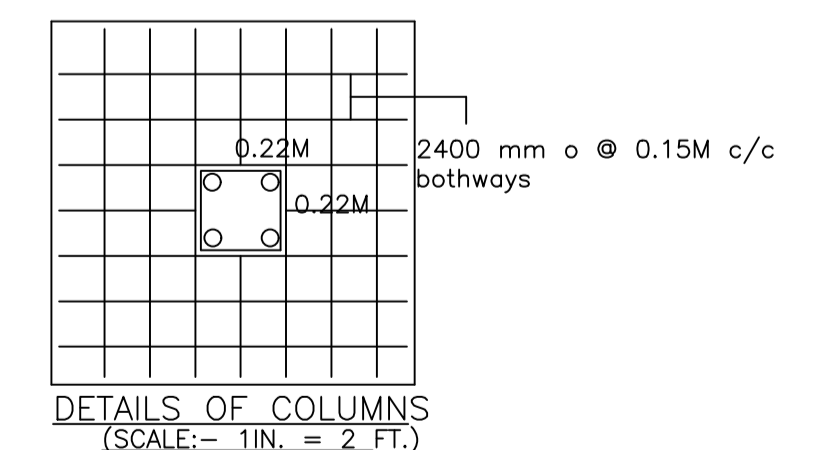
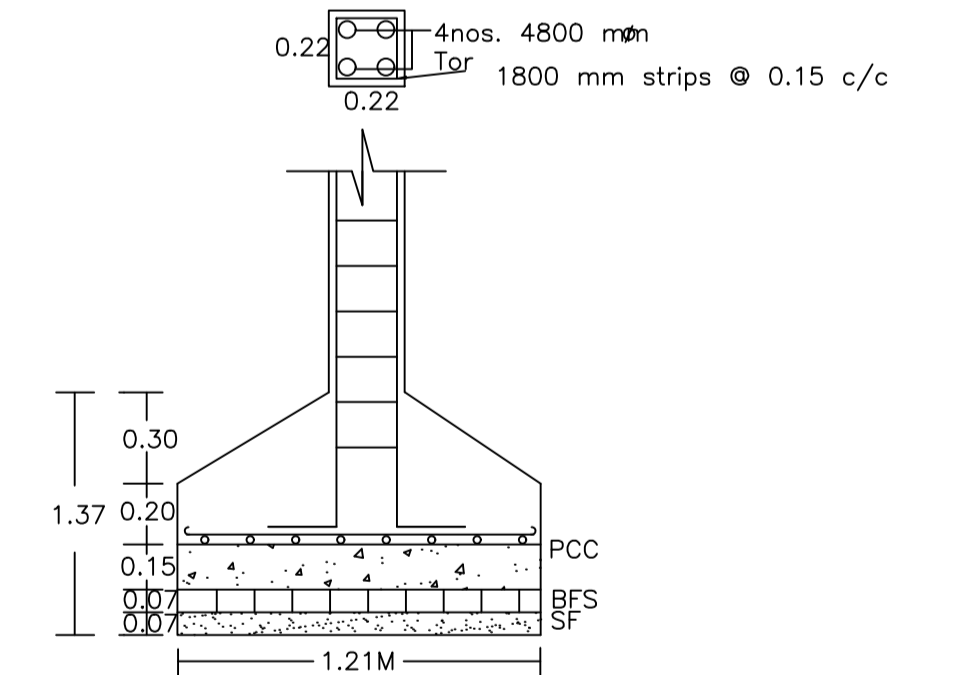

DETAILS OF COLUMNS
(SCALE:- 1IN. = 2 FT.)

LTP NAME AND SIGNATURE	STRUCTURAL ENG'S NAME AND SIGNATURE	SEAL AND SIGNATURE	REAL SIGNATURE
ANIL KUMAR CHOUDHARY DMC/ENG/0012/2016			