

1) SHAMSHUL ARFIN 2) NASREEN BANO

Project Title: 1. SHAMSHUL ARFIN, 2. NASREEN BANO

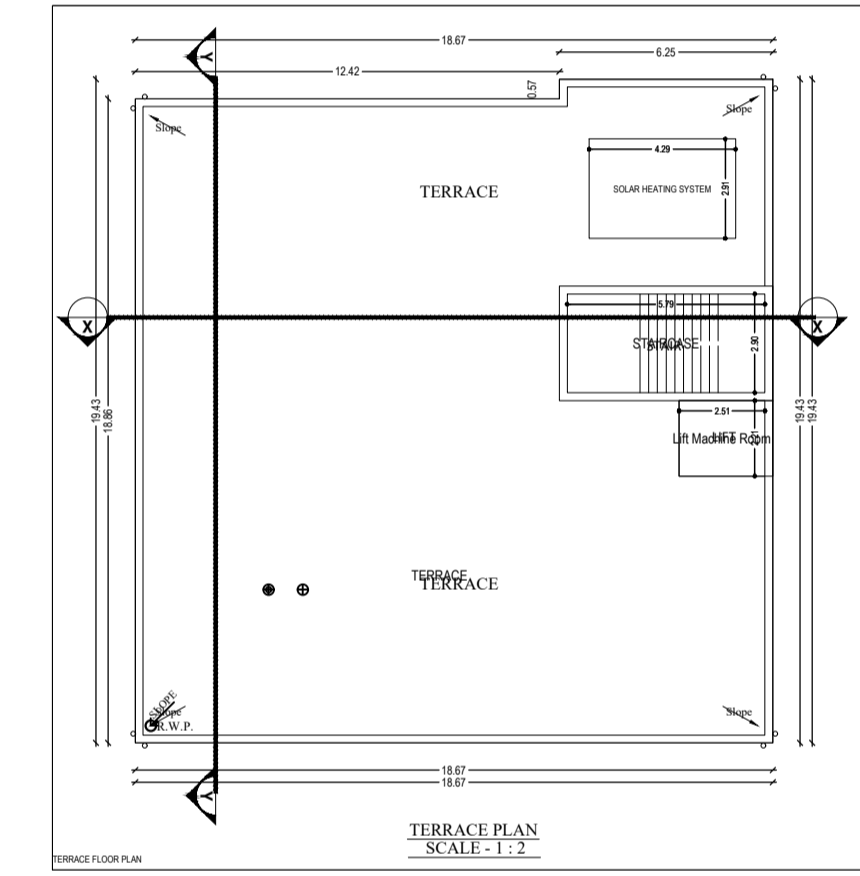
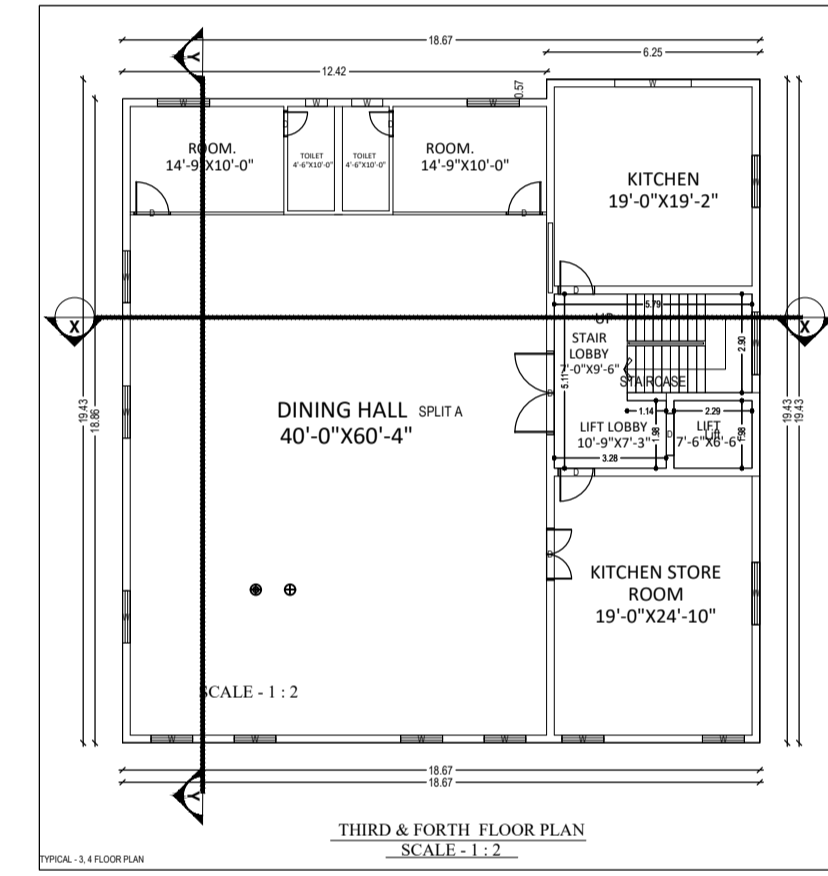
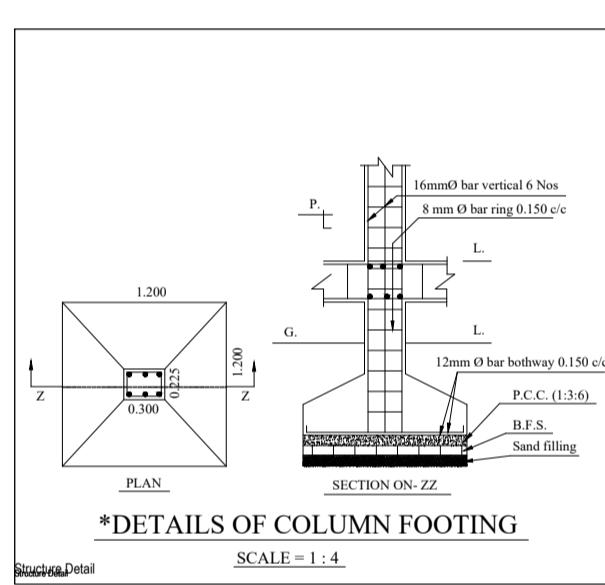
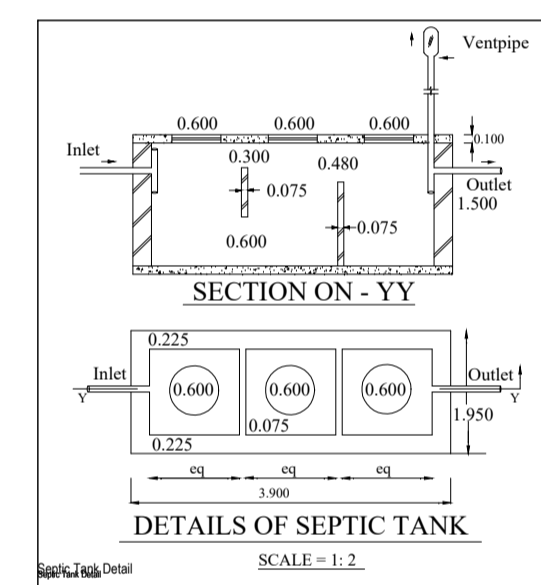
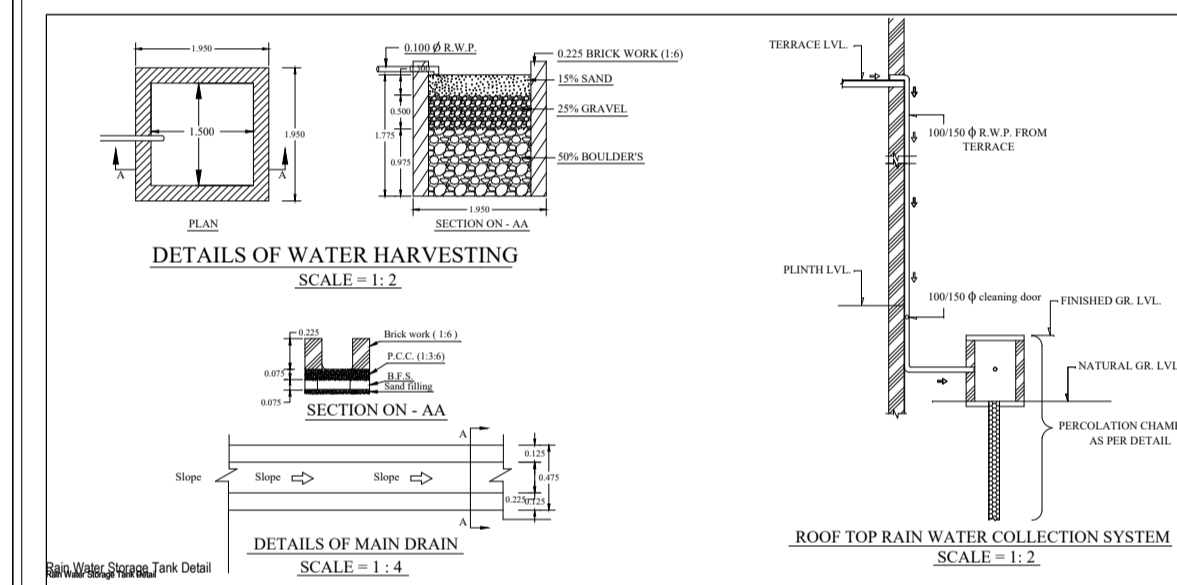
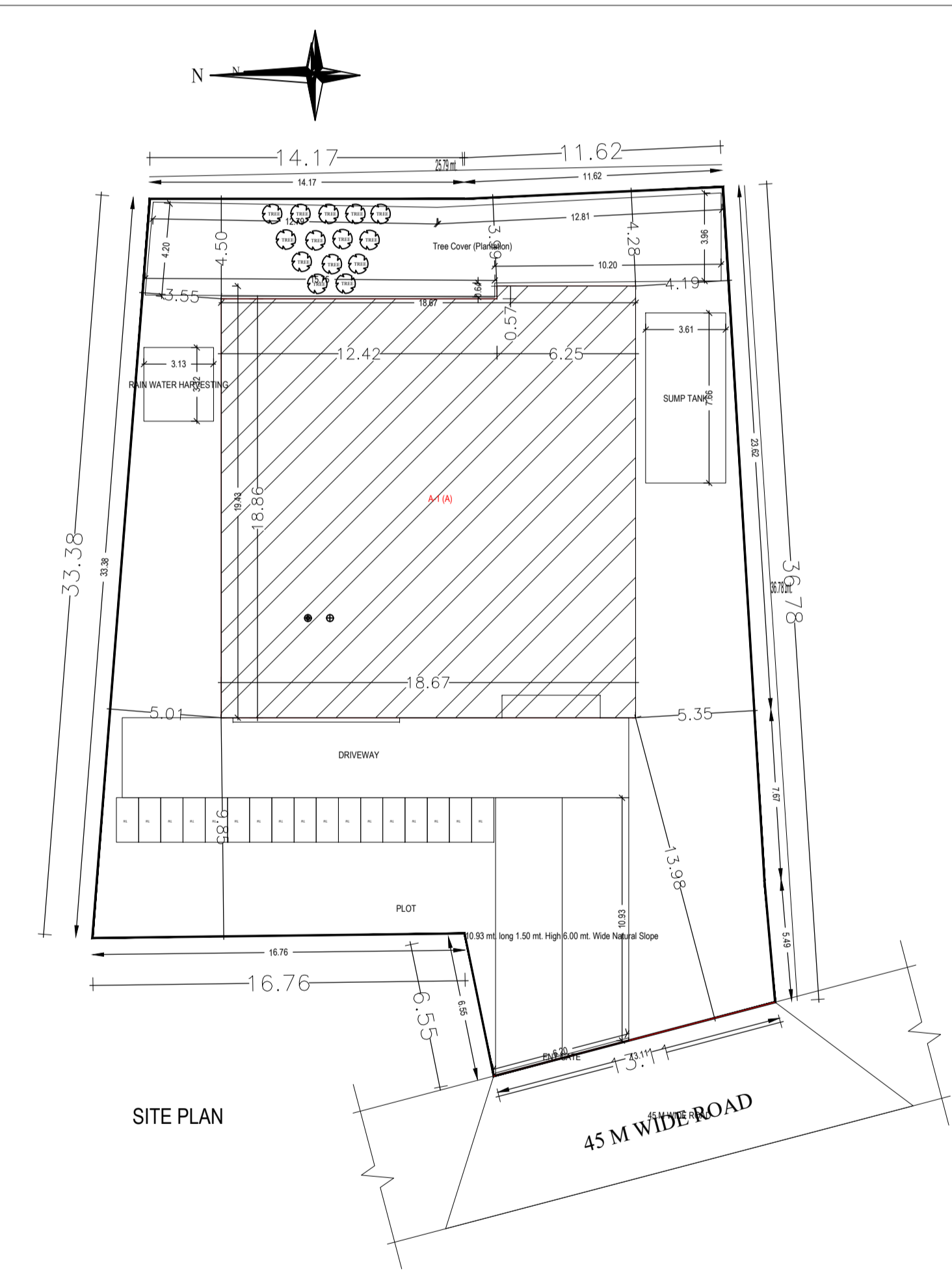
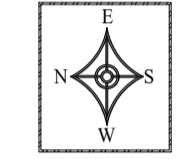
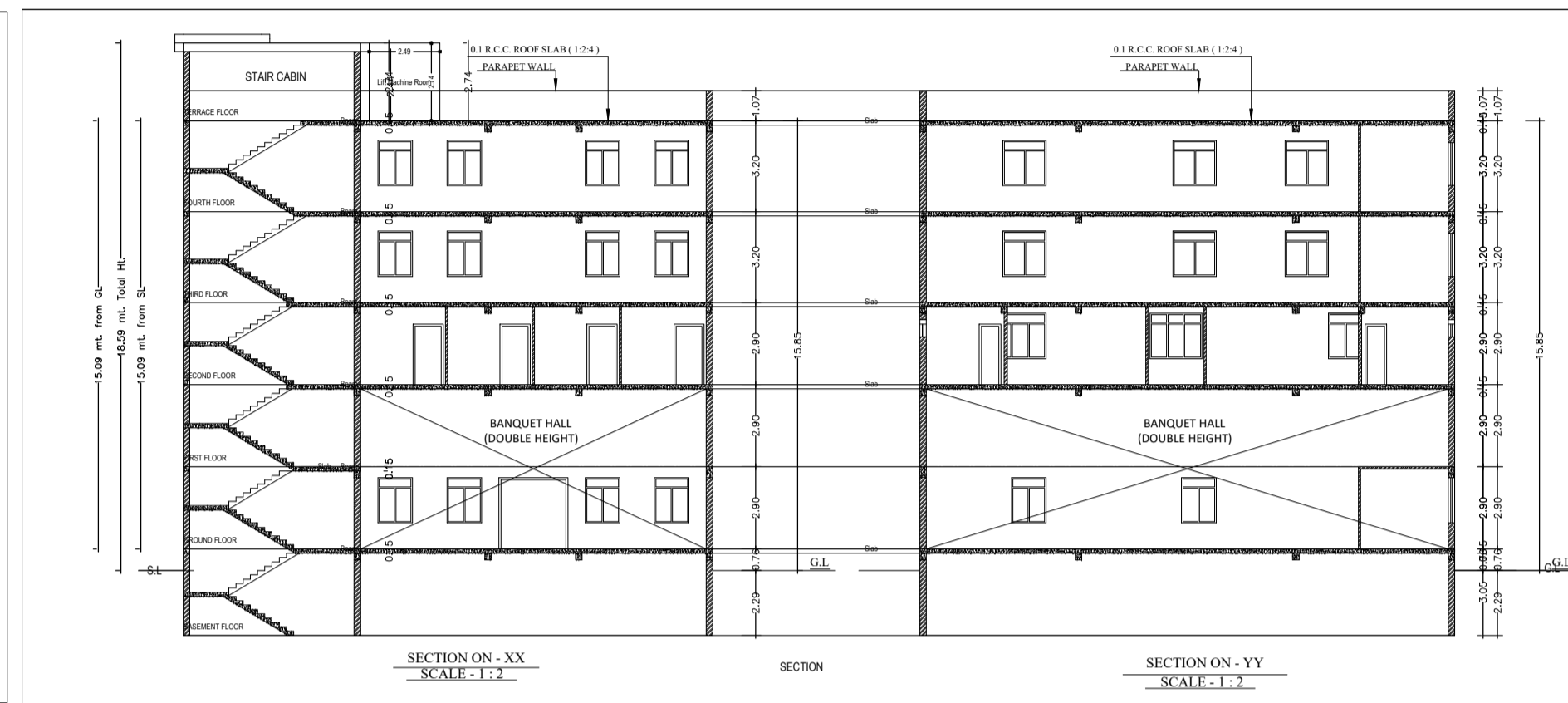
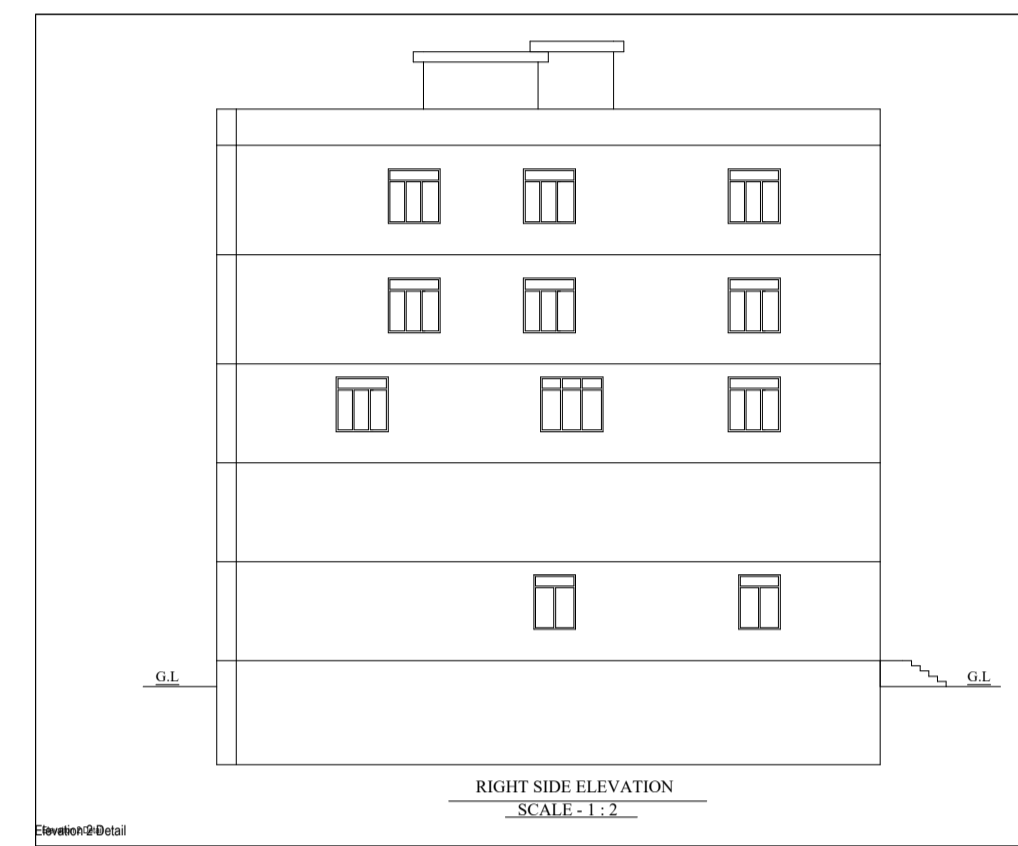

**BRIEF SPECIFICATION**

FOUNDATION :- R.C.C. (1:1.5:3) Column footing foundation  
 PLINTH :- 0.300 R.C.C. (1:1.5:3) all round on plinth level.  
 FLOORING :- 0.037 L.P.S. flooring over 3"th P.C.C. (1:2:4).  
 SUPER STRUCTURE :- First class brick work in cement mortar (1:6:3)  
 SLAB BEAM & LINTEL :- All R.C.C. work (1:1.5:3).  
 WOOD WORK :- All door & window frames of sal wood.  
 PLASTERING :- 0.012 cement plaster (1:6) both side.  
 \* COLUMN FOOTING :- Mark in plan just of positioning of column.

**SCHEDULE**

|               |                 |
|---------------|-----------------|
| D - 1.00X13   | W - 1.00X12.21  |
| D1 - 0.91X13  | W1 - 1.00X12.21 |
| D2 - 0.78X13  | W2 - 1.21X12.21 |
| MAG - 2.48X25 | WB - 0.80X0.52  |
|               | V - 0.50X0.45   |

**DETAILS OF AREA**

|                          |             |
|--------------------------|-------------|
| TOTAL AREA (As per deed) | 1003.98 Sqm |
| TOTAL AREA (As per site) | 999.81 Sqm  |
| BASEMENT AREA            | 355.67 Sqm  |
| GROUND AREA              | 355.67 Sqm  |
| FIRST FLOOR AREA         | 355.67 Sqm  |
| SECOND FLOOR AREA        | 355.67 Sqm  |
| THIRD FLOOR AREA         | 355.67 Sqm  |
| FOURTH FLOOR AREA        | 355.67 Sqm  |
| TOTAL COVERED AREA       | 2134.02 Sqm |
| % PLINTH AREA            | 35.66%      |
| F.A.R.                   | 2.1         |

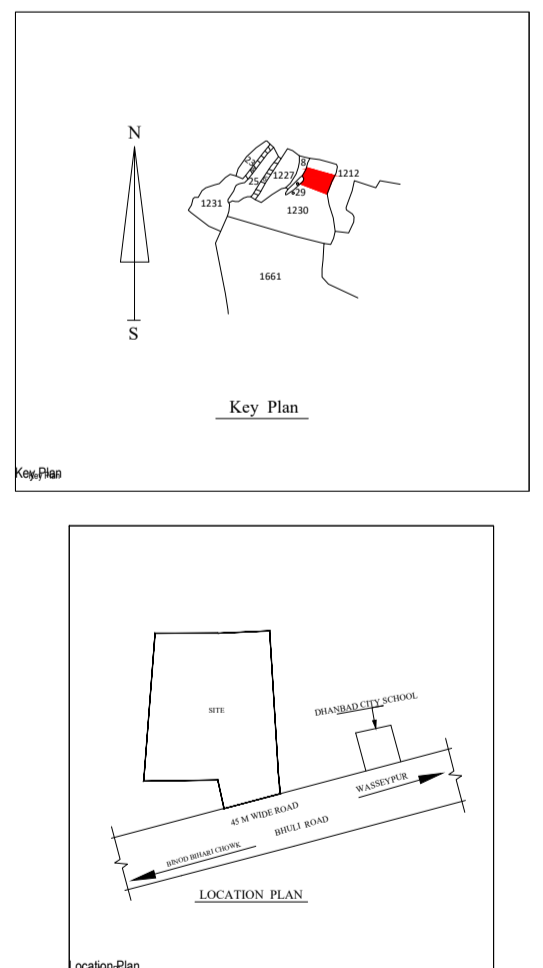
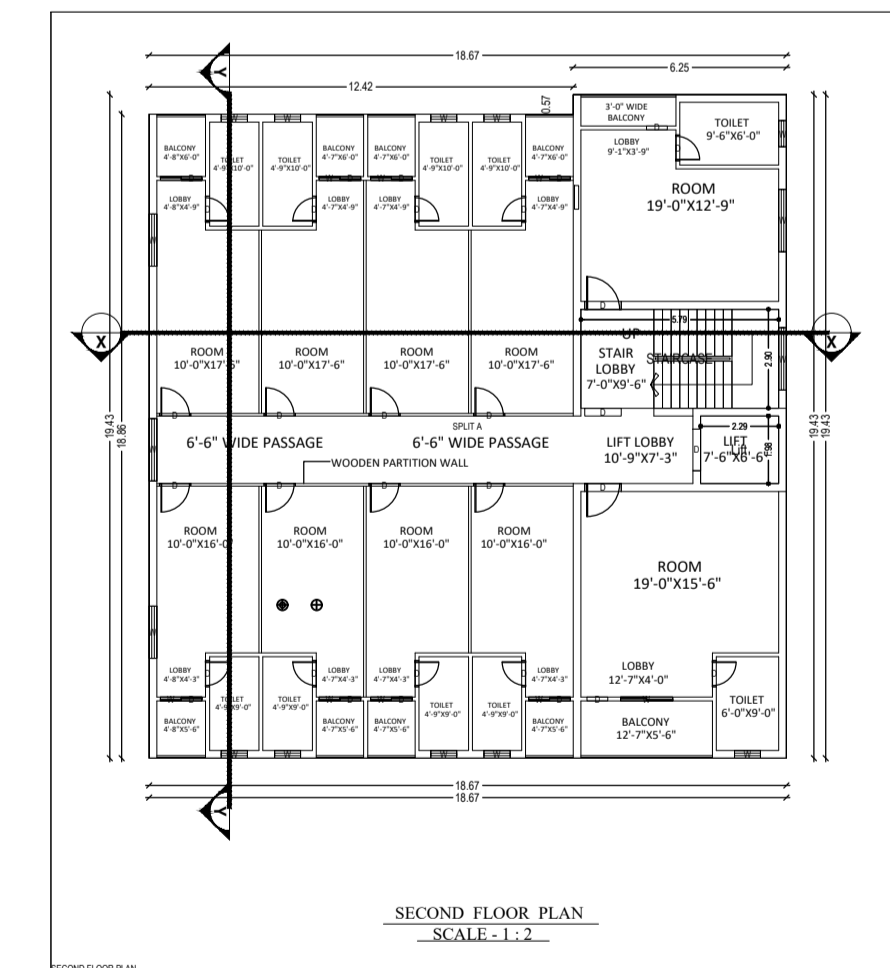
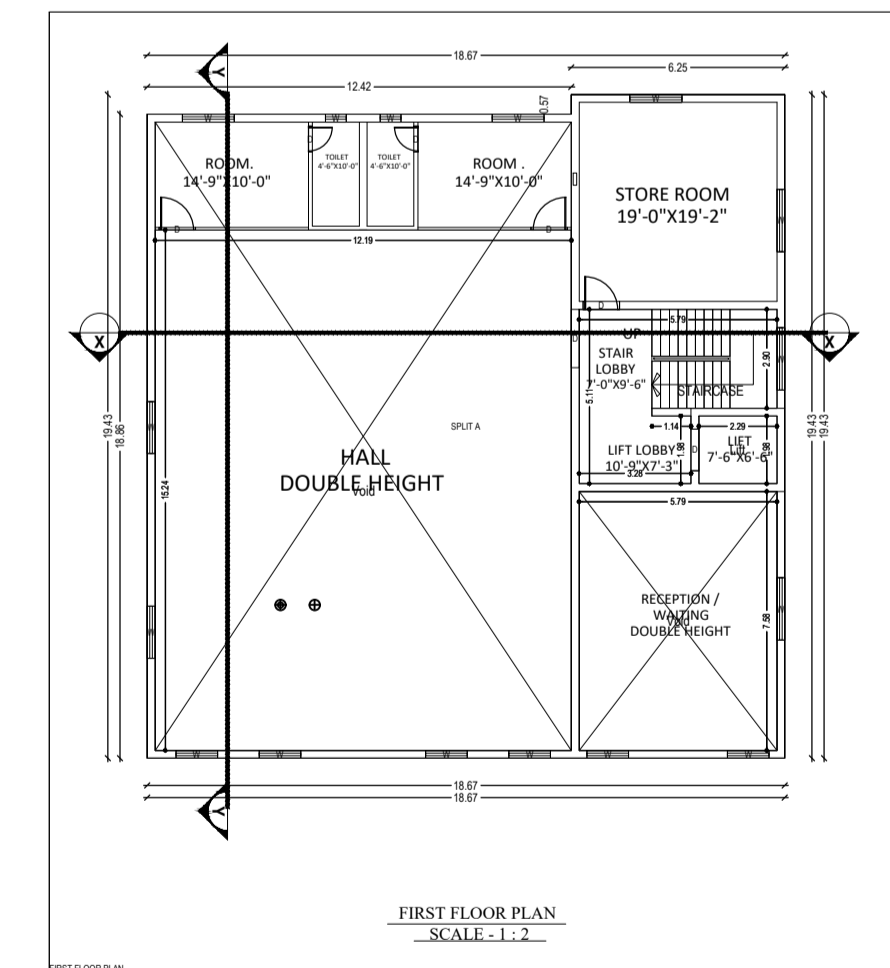
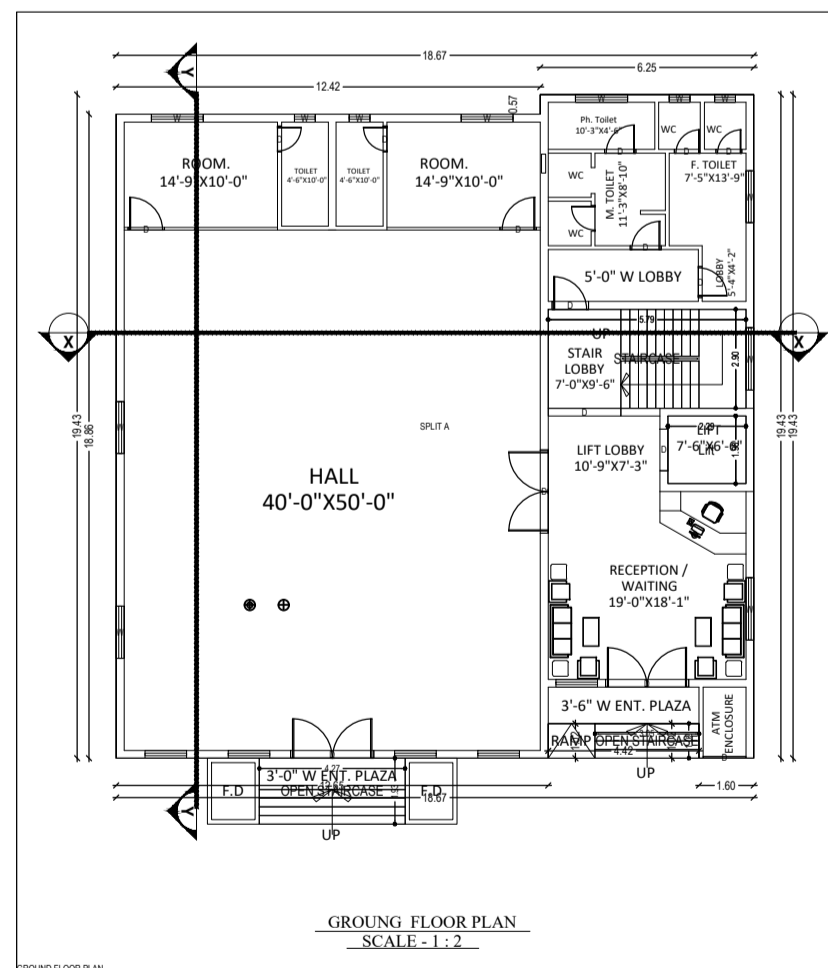
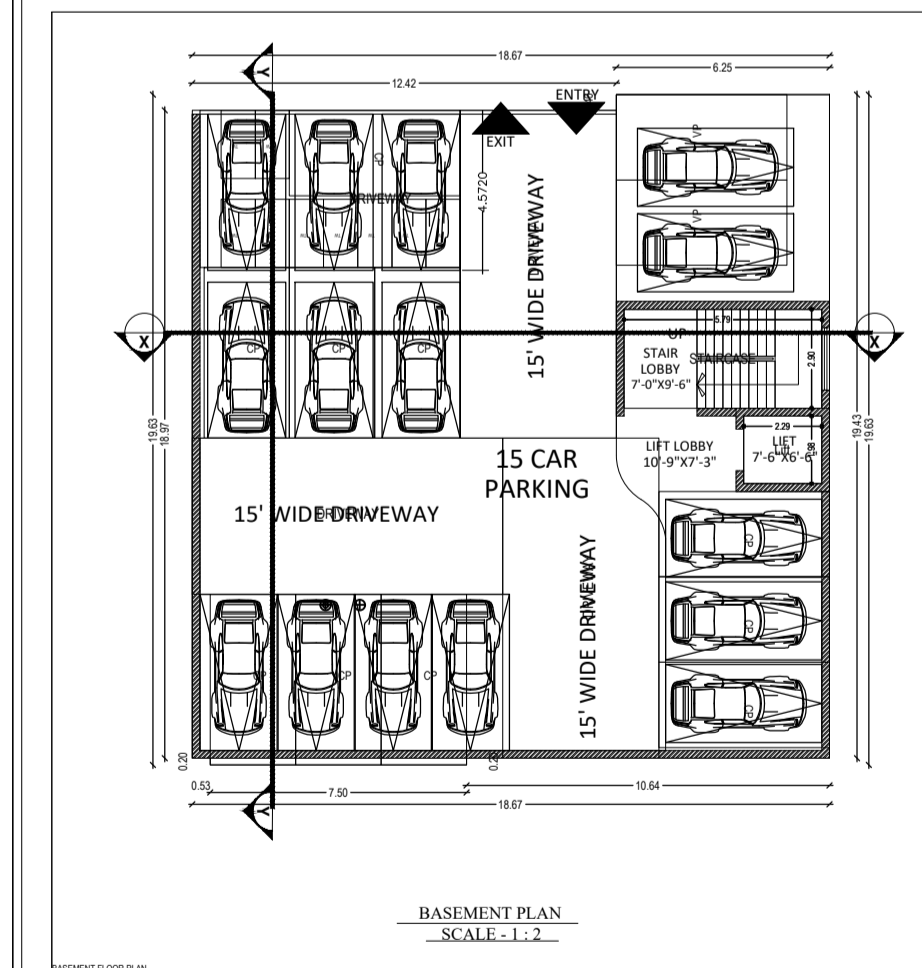

**TITLE OF DRAWING**

PROPOSED COMMERCIAL & RESIDENTIAL BUILDING PLAN OF 15 SHAMSHUL ARFIN & 15 NASREEN BANO AT 15 SHAMSHUL ARFIN & 15 NASREEN BANO, NEAR: DEHRANAD CITY SCHOOL, DEHRANAD DIST: DEHRANAD (UNDER MUZZA - PANDERPALA, MUZZA No. 04, 04D KHATA No. 04) (NEW KHATA No. 198, OLD PLOT No. 1230, NEW PLOT No. 1270, IN DEHRANAD, BARKHANA)

**SIG. OF OWNER**

**SIG. OF ENGINEER**