

SCHEDULE OF DOOR:

BUILDING NAME	NAME	LENGTH	HEIGHT	NOS
A (A)	d	0.90	2.10	12

SCHEDULE OF WINDOW/VENTILATION:

BUILDING NAME	NAME	LENGTH	HEIGHT	NOS
A (A)	w	1.80	1.20	18

UnitBUA Table for Building :A (A)

FLOOR	Name	UnitBUA Type	UnitBUA Area	Carpet Area	No. of Rooms	No. of Tenement
GROUND FLOOR PLAN	SPLIT 1	FLAT	160.28	160.27	7	1
FIRST FLOOR PLAN	SPLIT 1	FLAT	0.00	0.00	7	0
Total:			160.28	160.27	14	1

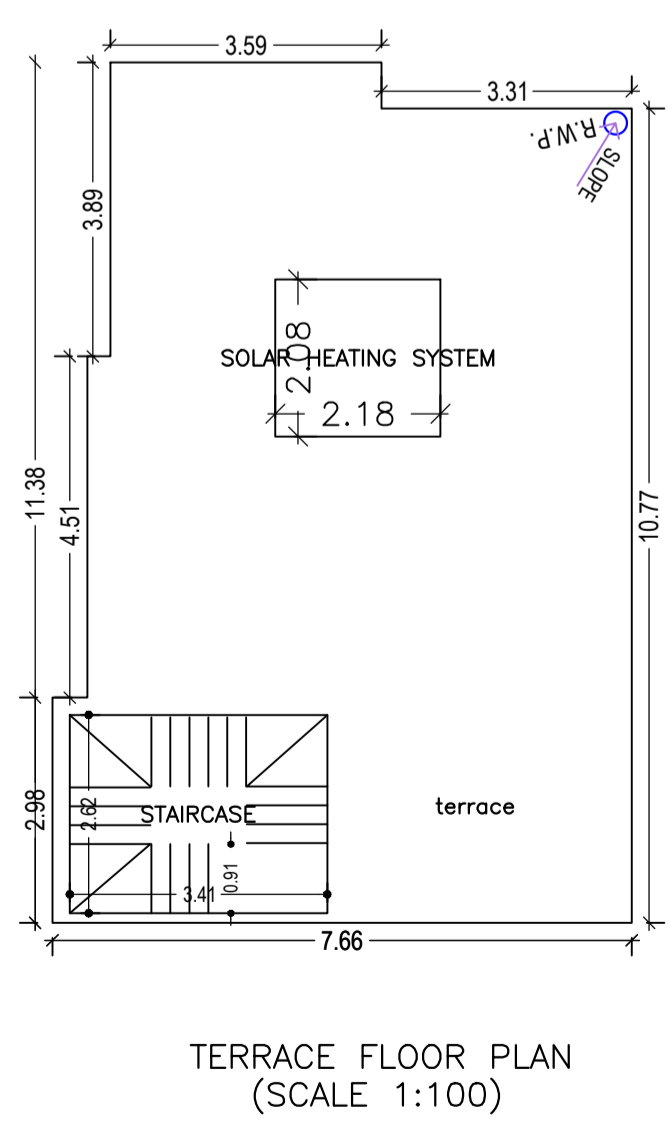
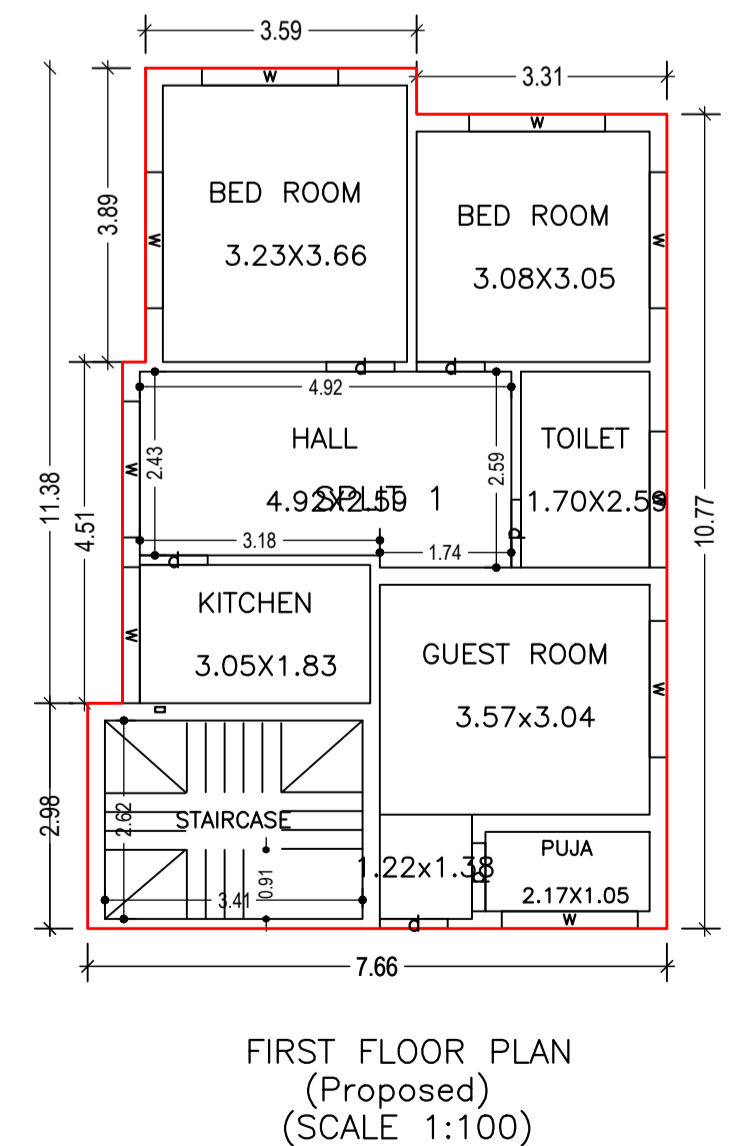
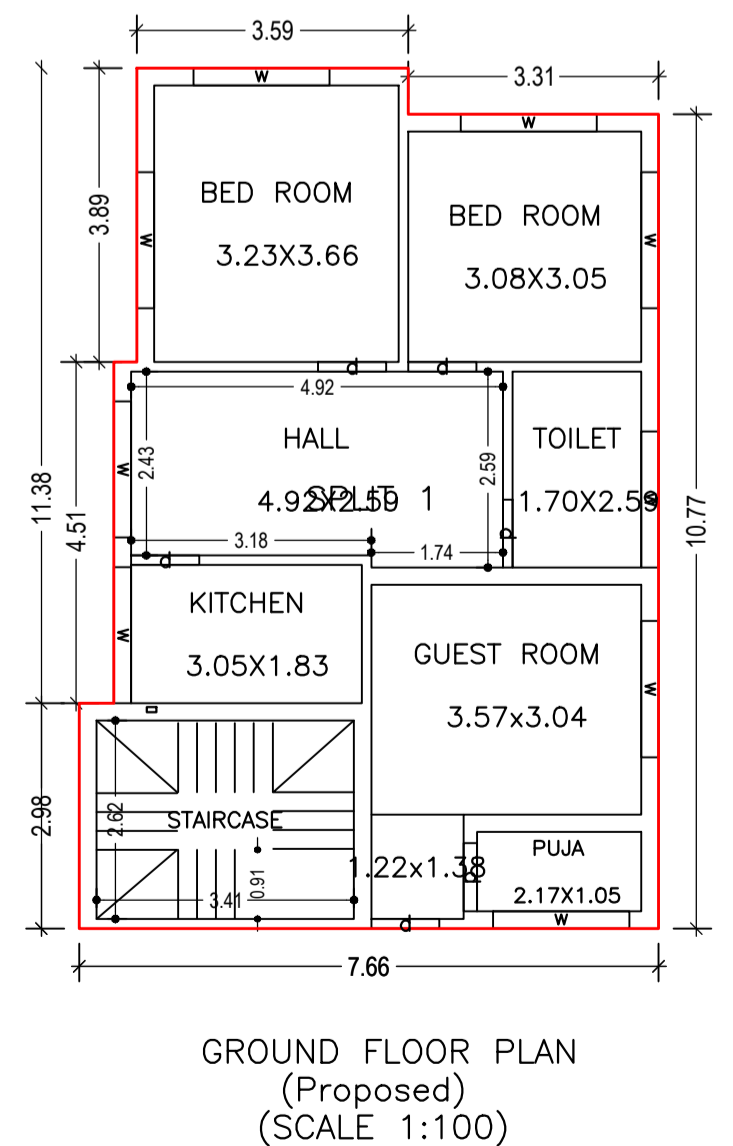

Proposal Basic Information

Proposal File No.	MADA/BP/0044/2020
Owner Name	SUCHITRA DEVI
Khata No	OLD - 42 , NEW - 85
Plot No	OLD - 1780 , NEW - 2051
Village Name	Damodarpur
Use	Residential
SubUse	Bungalow/ Dwelling / Non Apartment

AREA STATEMENT MINERAL

AREA OF PLOT (Minimum)	(A)	SQ.MT.
NET AREA OF PLOT(Gross Plot Area - Deduction from Gross Plot area)	(A-Deductions)	134.27
Deduction for Balance Plot Area(from Gross Plot Area)		
Common Plot		18.67
Total		18.67
BALANCE AREA OF PLOT(Net Plot Area - Recreational/Amenity space)	(A-Deductions)	115.60
PLOT AREA FOR COVERAGE(Net Plot Area)	(A-Deductions)	134.27
Plot Area for FAR (Net Plot Area + Road/Widening Area)	(A-Deductions)	134.27
COVERAGE CHECK		
Permissible Coverage area (70.00 %)		93.99
Proposed Coverage Area (59.68 %)		80.14
Total Prop. Coverage Area (59.68 %)		80.14
Balance coverage area (10.31 %)		13.85
FAR CHECK		
Perm. FAR Area (1.50)		201.40
Total Perm. FAR area		201.40
Residential FAR		160.28
Proposed FAR Area		160.28
Total Proposed FAR Area		160.28
Consumed FAR (Factor)		1.19
Balance FAR Area		41.12
BUILT UP AREA CHECK		
Total Proposed BuiltUp Area		160.28
ARCHITECT (Regd)		
ENGINEER (Regd)		MANOJ KUMAR SINGH
SUPERVISOR (Regd)		
OWNER (Regd)		SUCHITRA DEVI
DEVELOPMENT AUTHORITY		
		LOCAL BODY

COLOR INDEX

PLOT BOUNDARY	Black
ABUTTING ROAD	Green
PROPOSED CONSTRUCTION	Red
COMMON PLOT	Yellow
ROAD WIDENING AREA	Blue
EXISTING (To be retained)	Light Blue
EXISTING (To be demolished)	Dark Blue

Buildingwise Floor FAR Details

Floor Name	Building Name A (A)		Total	
	Proposed Built Up Area (Sq.mt.)	Proposed FAR Area (Sq.mt.)	Total Proposed Built Up Area (Sq.mt.)	Total FAR Area (Sq.mt.)
Ground Floor	80.14	80.14	80.14	80.14
First Floor	80.14	80.14	80.14	80.14
Terrace Floor	0.00	0.00	0.00	0.00
Total :	160.28	160.28	160.28	160.28

Building USE/SUBUSE Details

Building Name A (A)	Building Use Residential	Building SubUse Residential Bldg/Apartment	Building Structure Non-Highrise
---------------------	--------------------------	--	---------------------------------

FAR & Tenement Details (Table 4c-1)

Building	No. of Same Bldg	Total Built Up Area (Sq.mt.)	Proposed FAR Area (Sq.mt.) Res.	Total FAR Area (Sq.mt.)	Total Consumed Additional FAR Area (Sq.mt.)	Tnmt (No.)
A (A)	1	160.28	160.28	160.28	160.28	01
Grand Total :	1	160.28	160.28	160.28	160.28	01

Building :A (A)

Floor Name	Total Built Up Area (Sq.mt.)	Proposed FAR Area (Sq.mt.) Res.	Total FAR Area (Sq.mt.)	Total Consumed Additional FAR Area (Sq.mt.)	Tnmt (No.)
Ground Floor	80.14	80.14	80.14	80.14	01
First Floor	80.14	80.14	80.14	80.14	00
Terrace Floor	0.00	0.00	0.00	0.00	00
Total :	160.28	160.28	160.28	160.28	01
Total Number of Same Buildings :	1				

LTP NAME AND SIGNATURE: MANOJ KUMAR SINGH, MADA/DFT/MN/0023/2019
STRUCTURAL ENGS NAME AND SIGNATURE: _____
BUILDER NAME AND SIGNATURE: _____
DIGITAL SIGNATURE: _____

Proposal Basic Information

Proposal File No.	MADA/BP/0044/2020
Owner Name	SUCHITRA DEVI
Khata No	OLD - 42 , NEW - 85
Plot No	OLD - 1780 , NEW - 2051
Village Name	Damodarpur
Use	Residential
SubUse	Bungalow/ Dwelling / Non Apartment

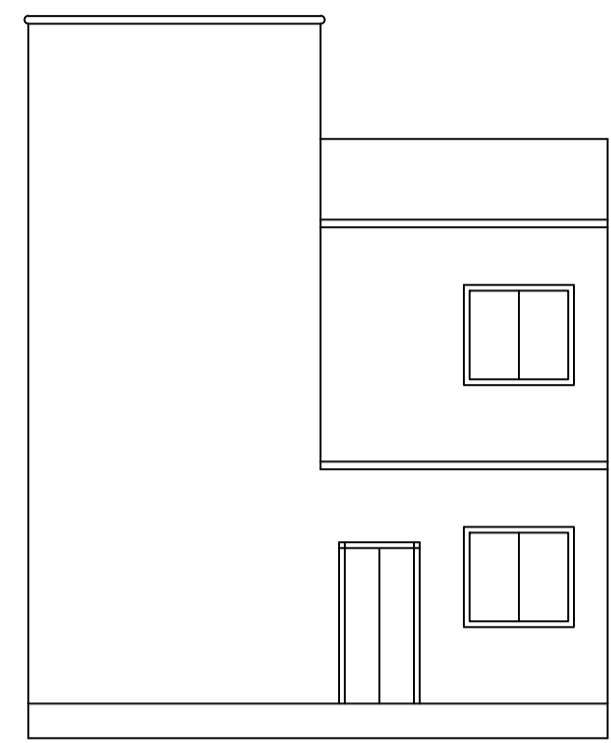

FRONT ELEVATION

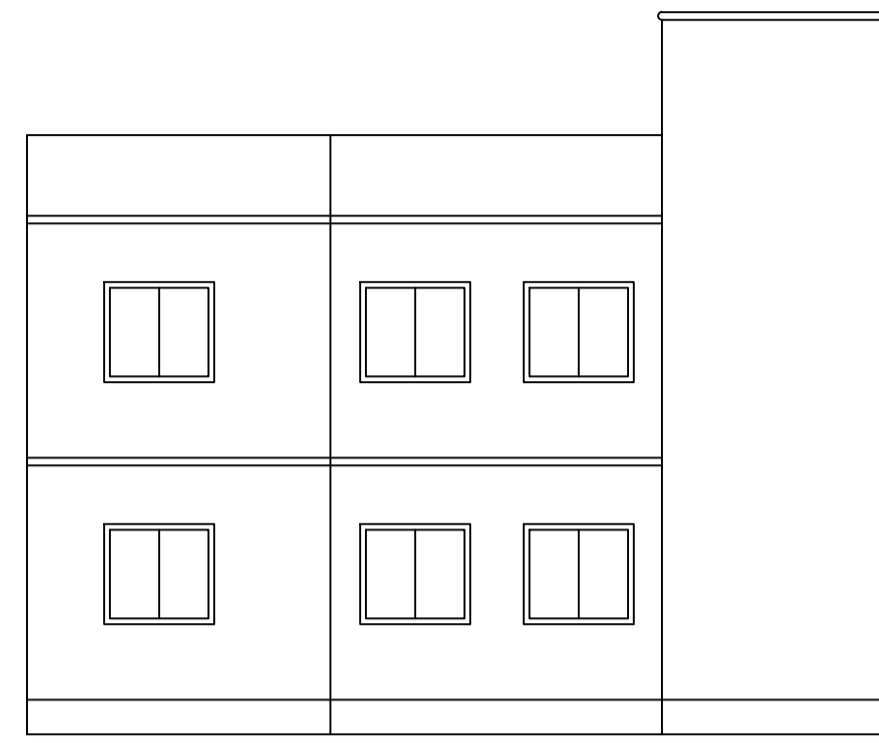

LEFT SIDE ELEVATION

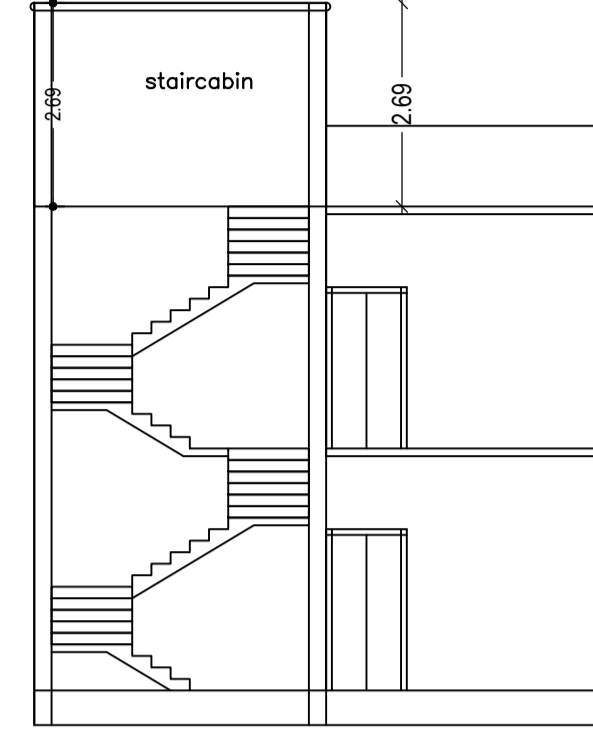

SECTION AT X-X

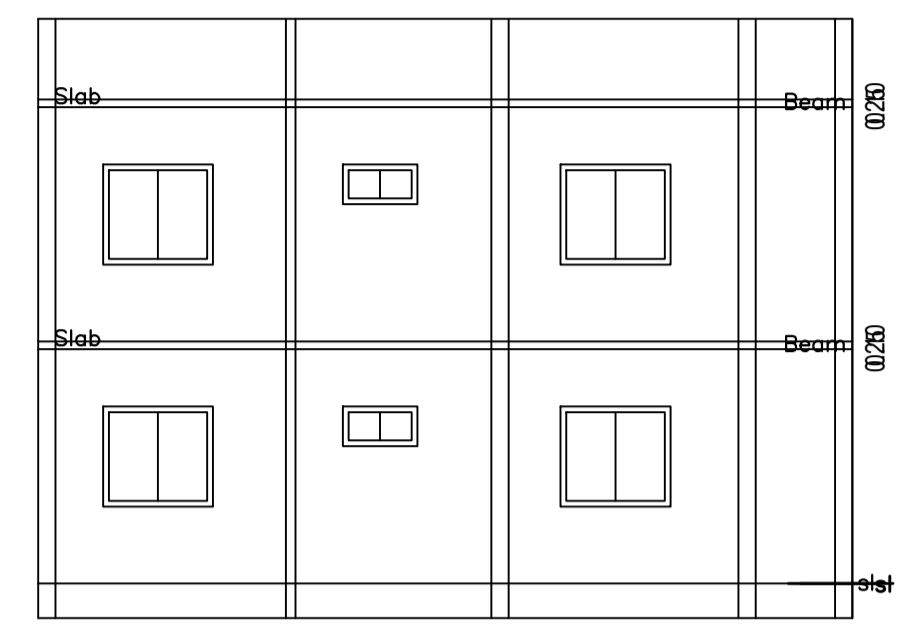

SECTION ON Y-Y

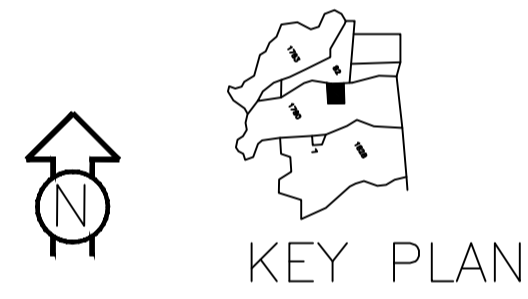

KEY PLAN

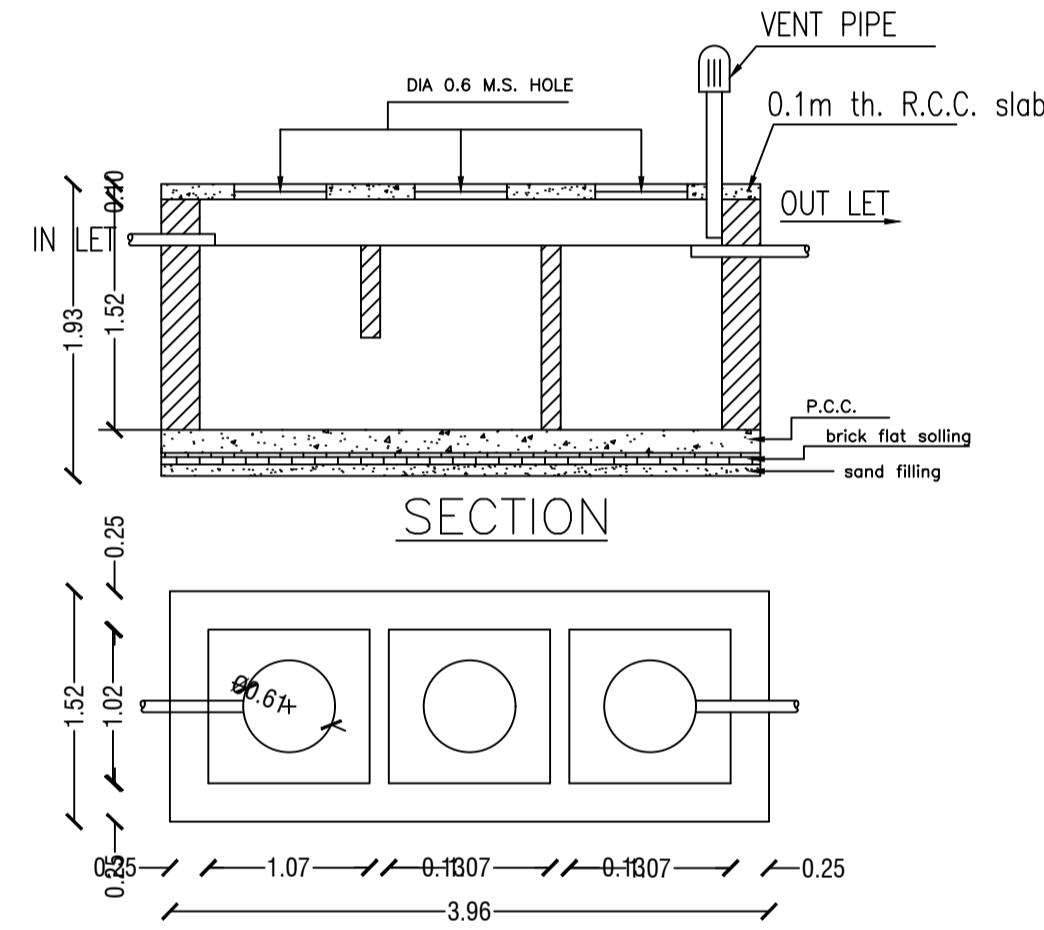
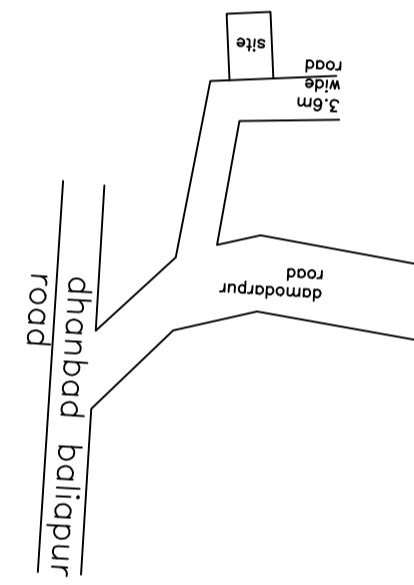

DETAILS OF SEPTIC TANK

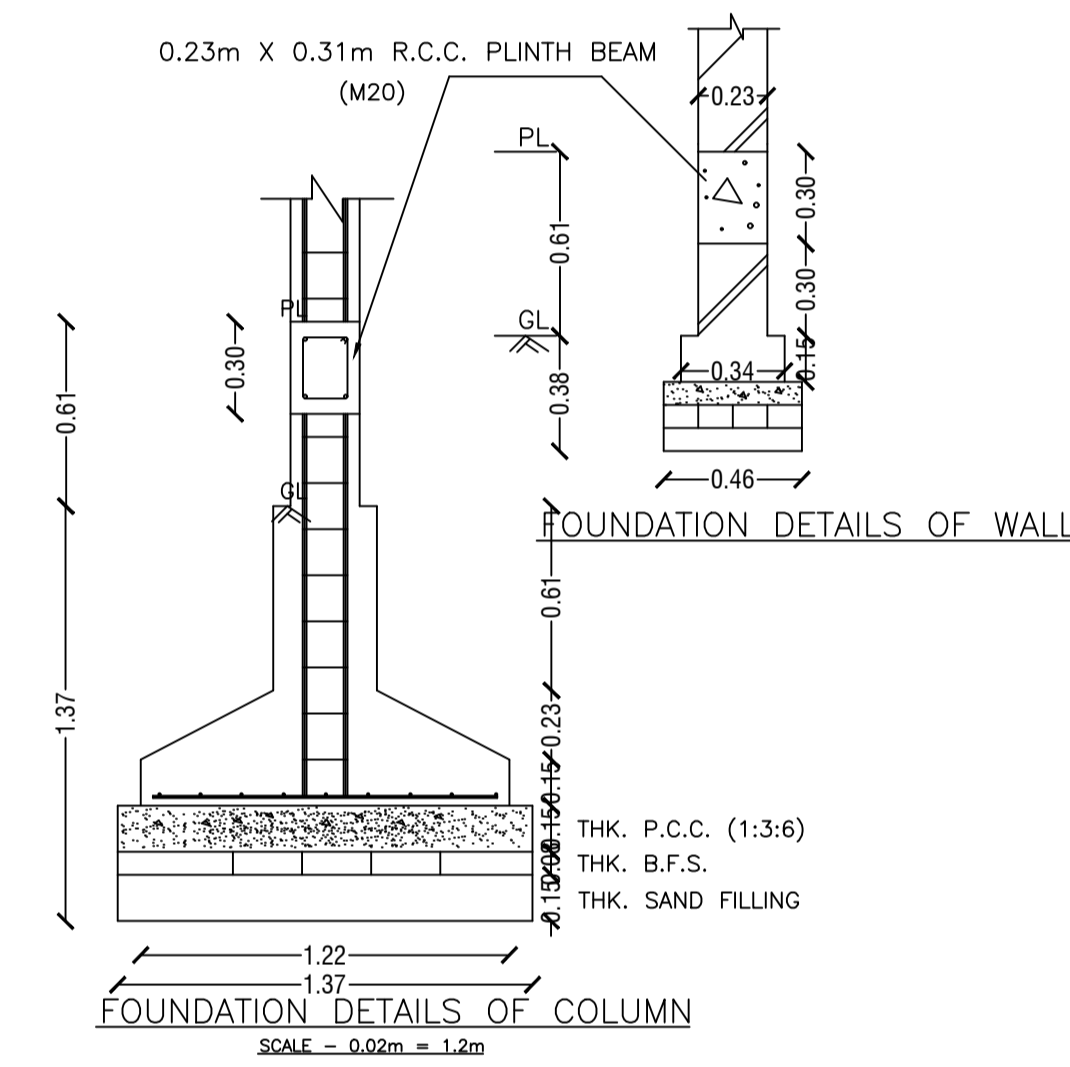

FOUNDATION DETAILS OF WALL

FOUNDATION DETAILS OF COLUMN

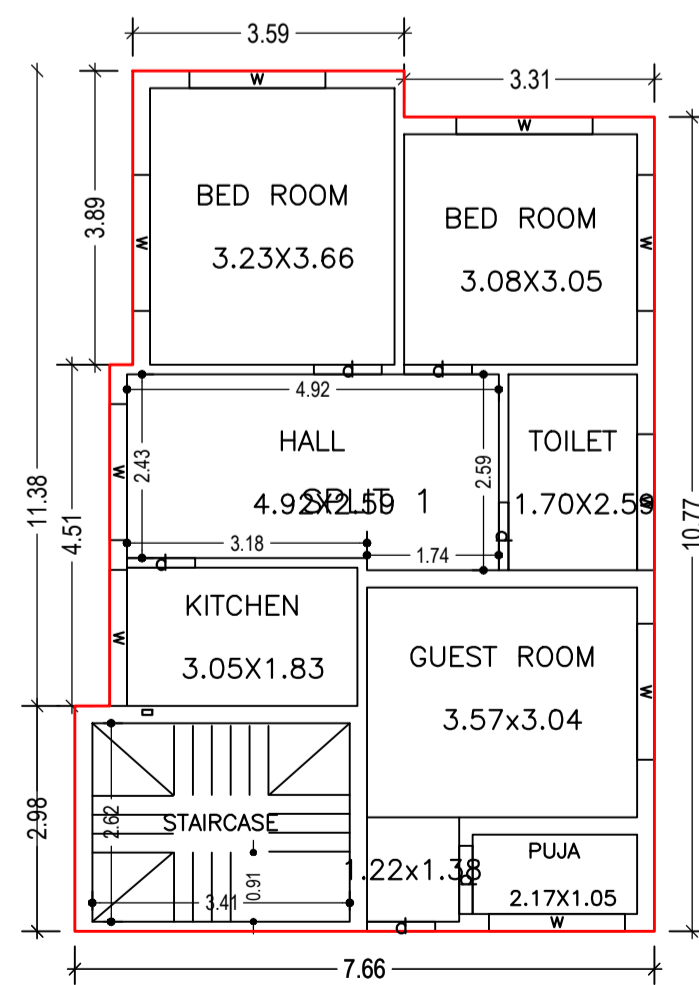

GROUND FLOOR PLAN (Proposed) (SCALE 1:100)

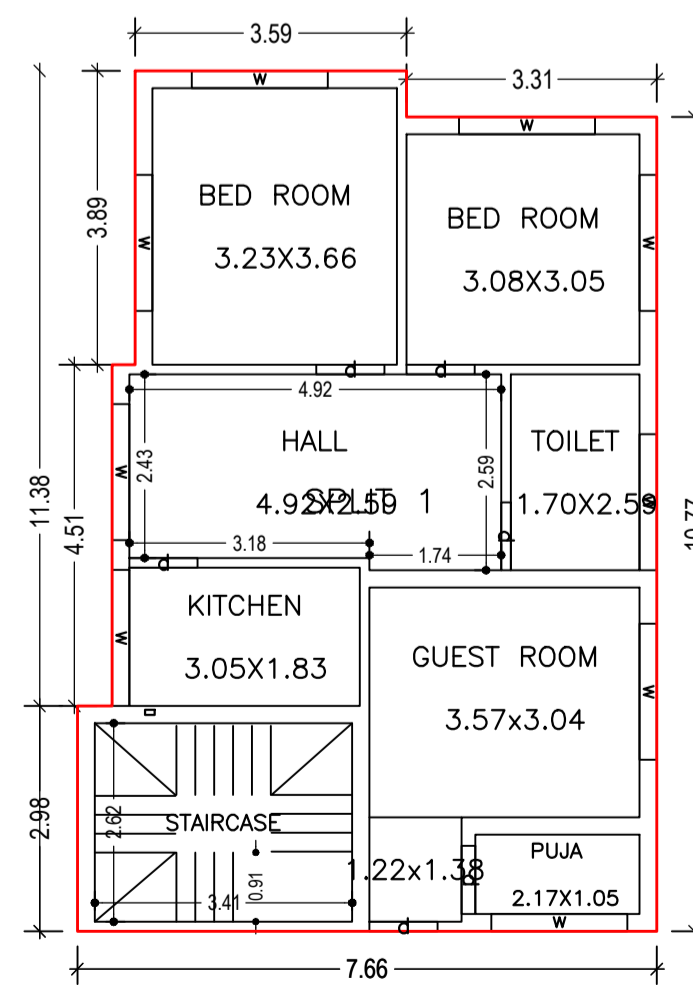

FIRST FLOOR PLAN (Proposed) (SCALE 1:100)

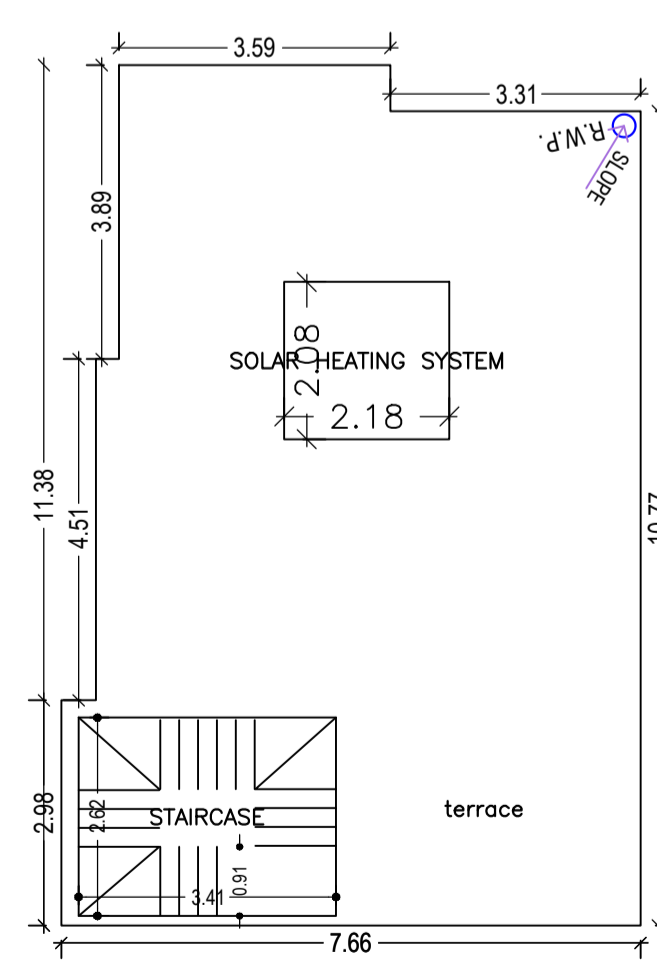

TERRACE FLOOR PLAN (SCALE 1:100)

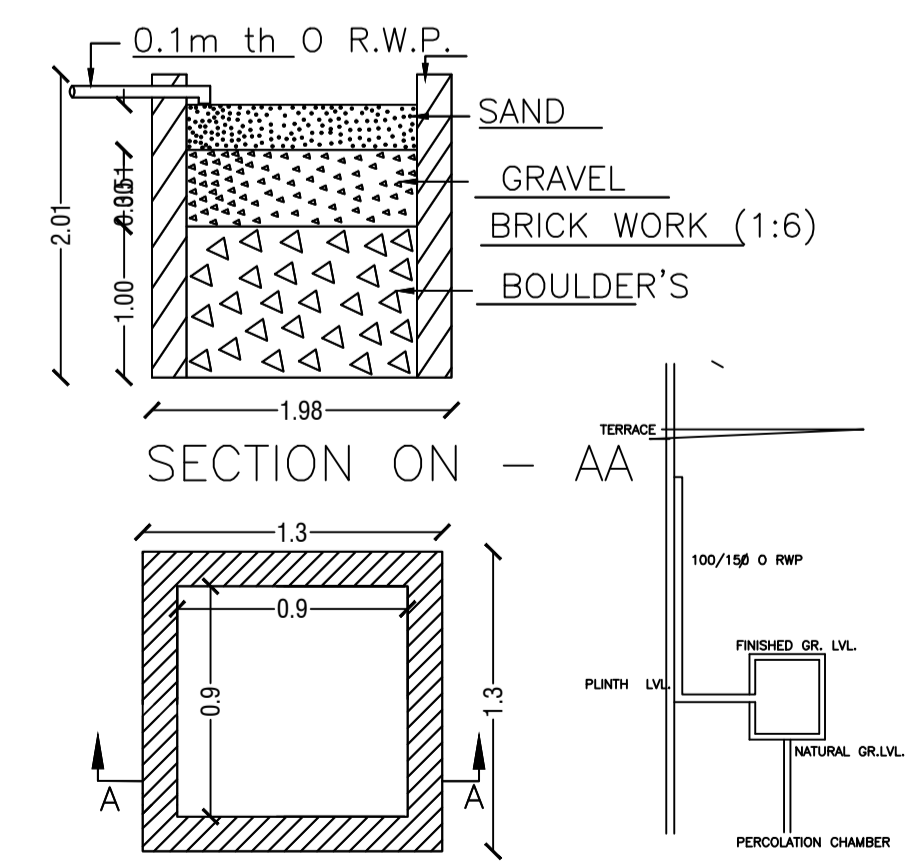

DETAIL'S OF WATER HARVESTING

LTP NAME AND SIGNATURE	STRUCTURAL ENG'S NAME AND SIGNATURE	BUILDER NAME AND SIGNATURE	DIGITAL SIGNATURE
MANOJ KUMAR SINGH MADA/DFTMN/0023/2019			