

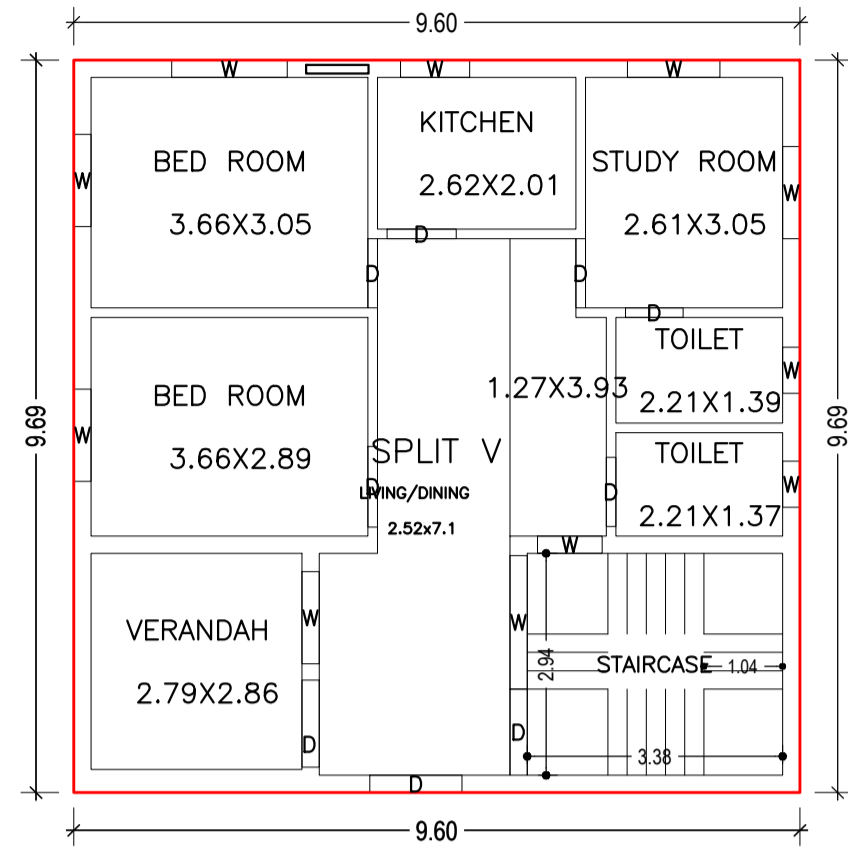

Proposal Basic Information	
Proposal File No.	MADA/BP/0080/2021
Owner Name	SMT ANJU DEVI
Khata No	NEW - 144 , OLD - 03
Plot No	NEW - 1645 , OLD - 1450
Village Name	Nawadhi
Use	Residential
SubUse	Bungalow/ Dwelling / Non Apartment

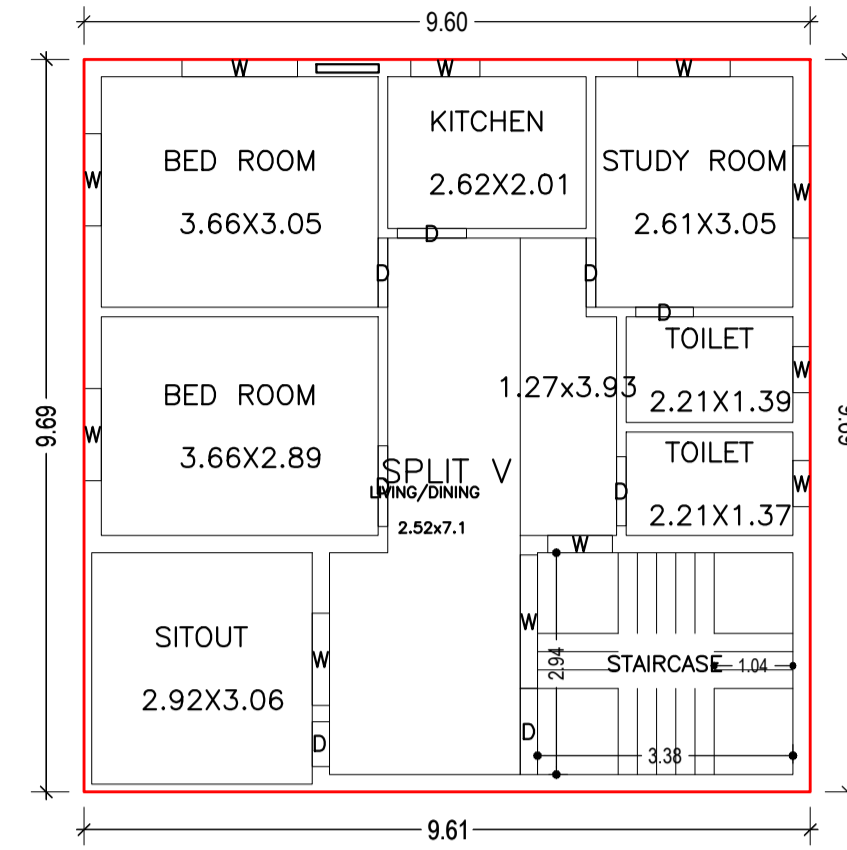

GROUND FLOOR PLAN  
(Proposed)  
(SCALE 1:100)



FIRST FLOOR PLAN  
(Proposed)  
(SCALE 1:100)

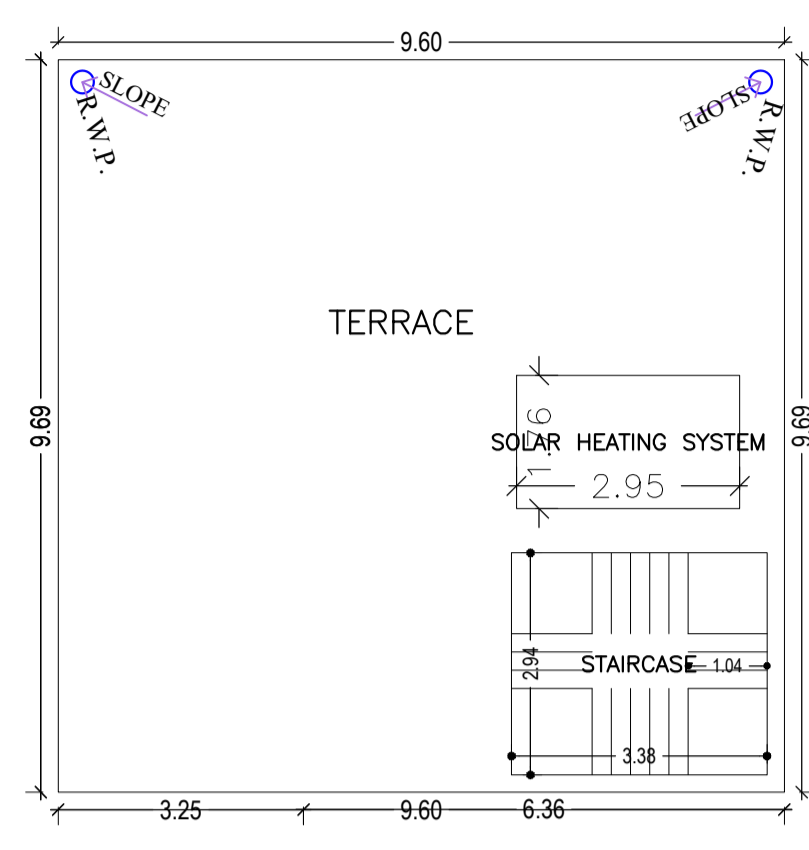

TERRACE FLOOR PLAN  
(SCALE 1:100)

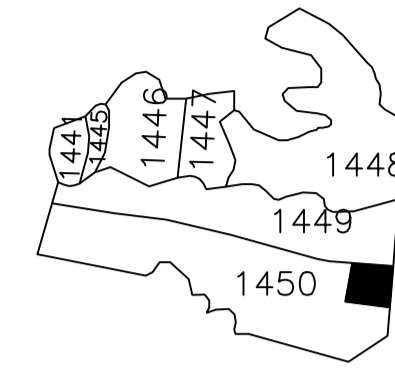

KEY PLAN

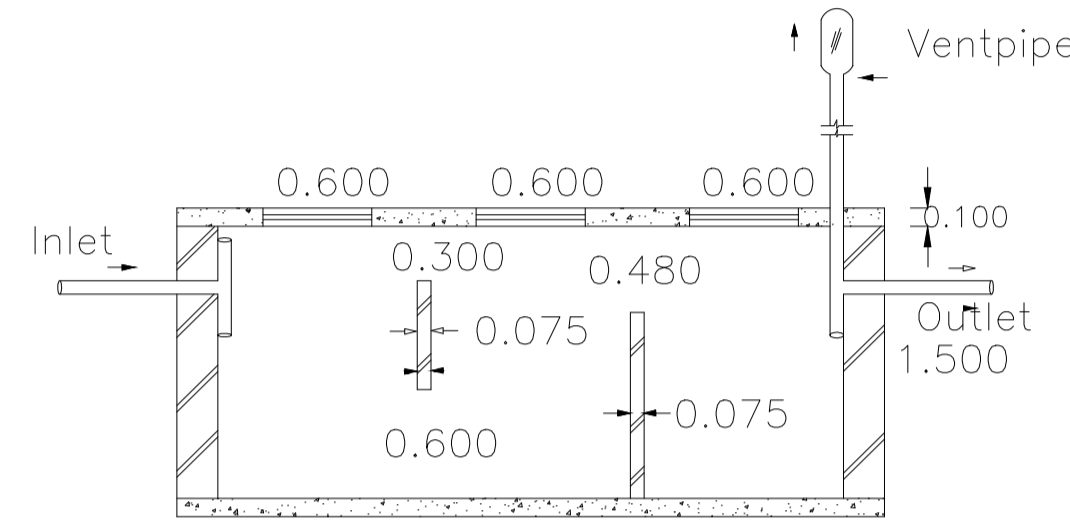

SECTION ON - YY

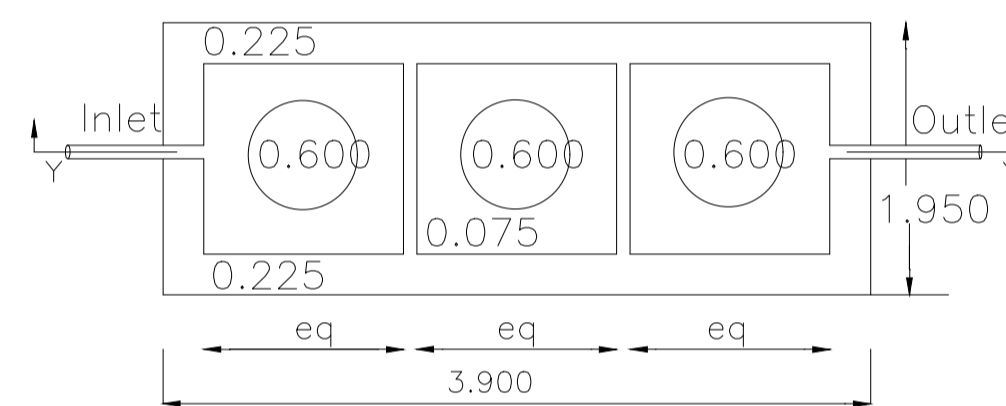

DETAILS OF SEPTIC TANK

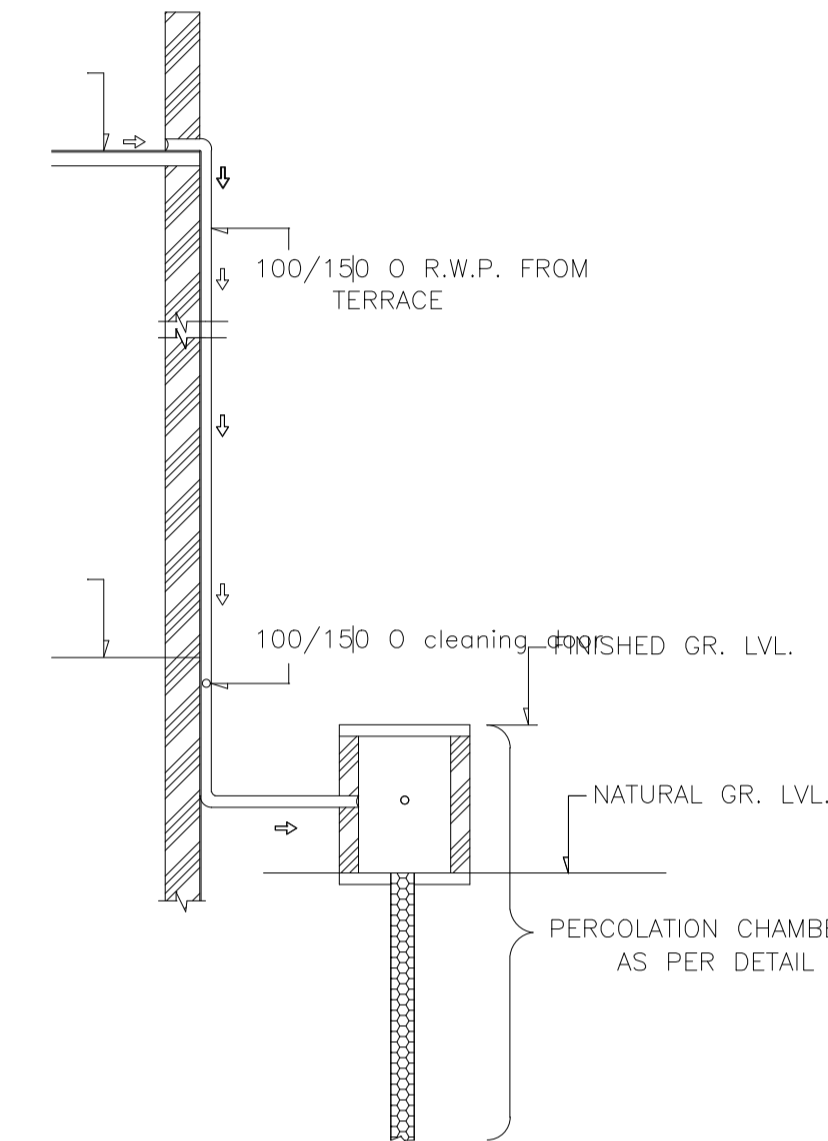

ROOF TOP RAIN WATER COLLECTION SYSTEM

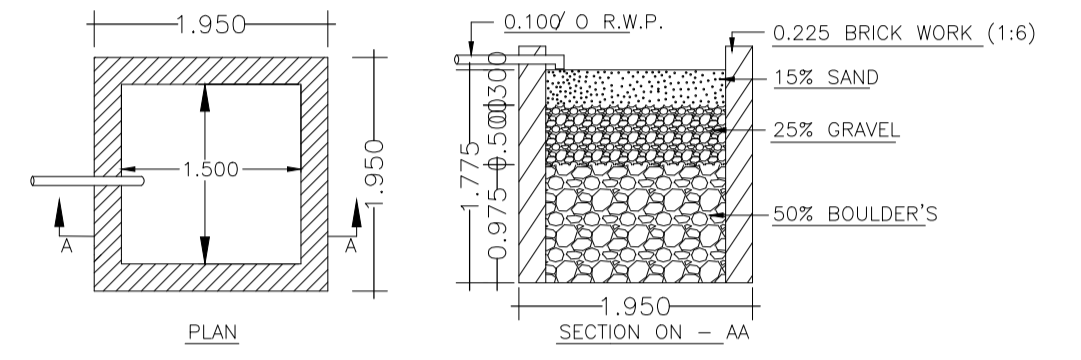

DETAILS OF WATER HARVESTING

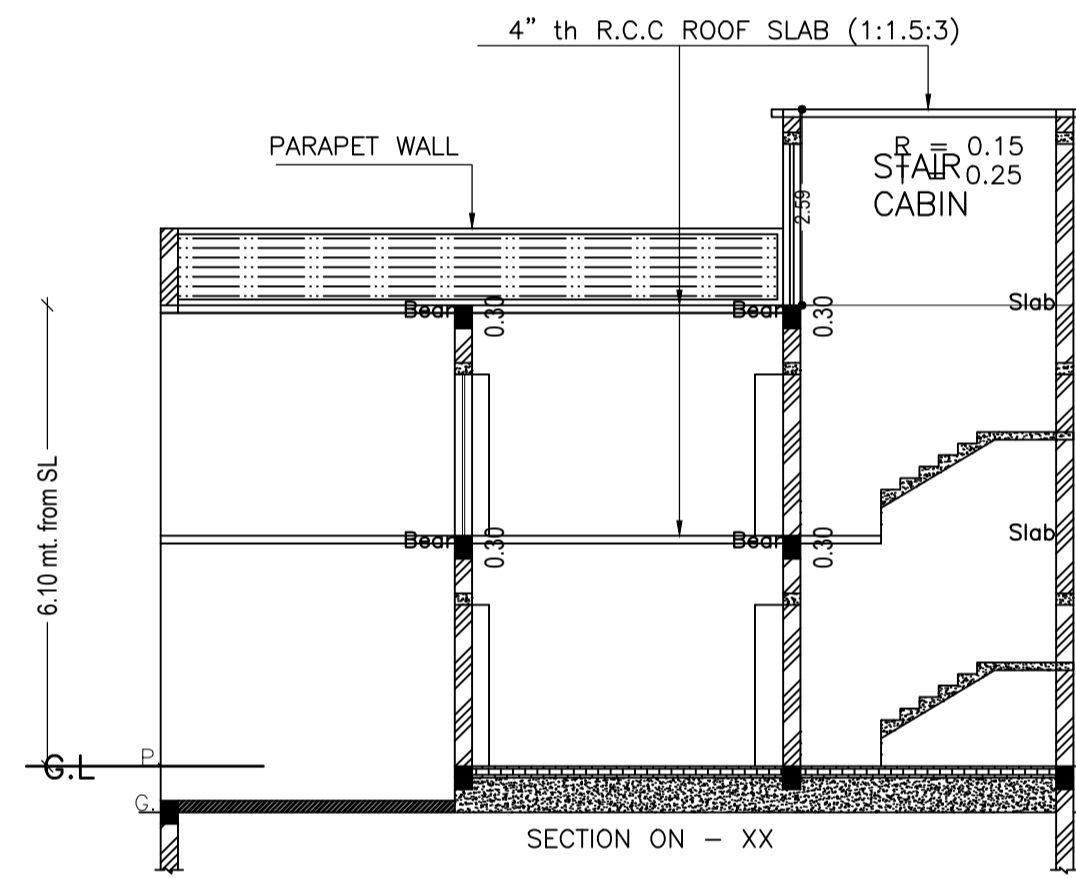

SECTION ON - XX

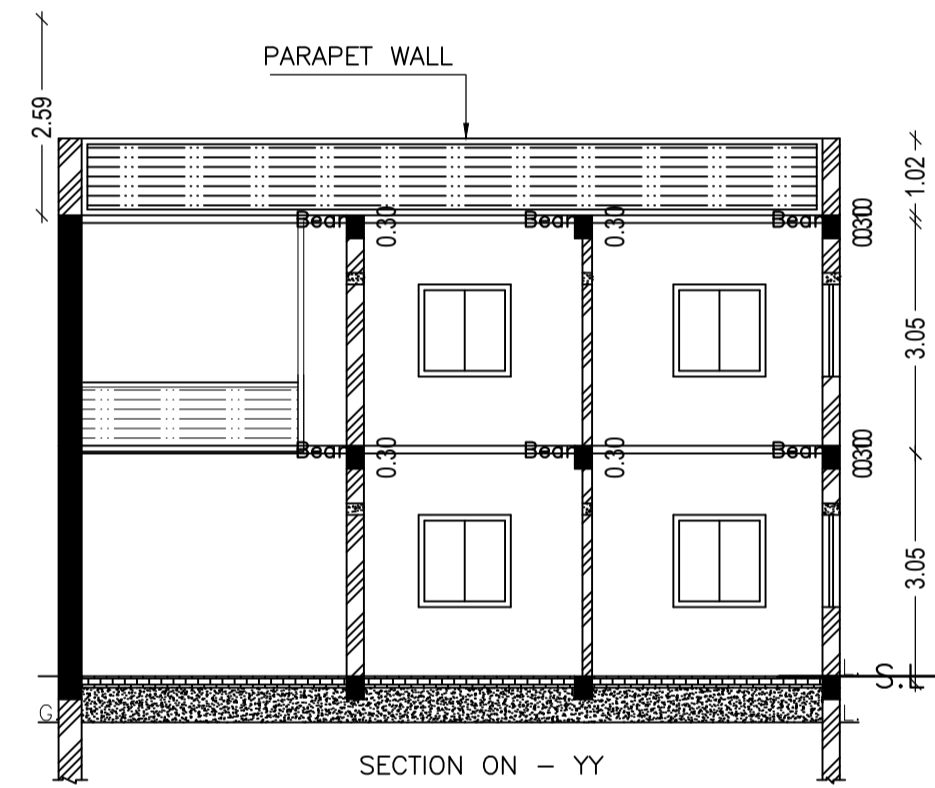

SECTION ON - YY

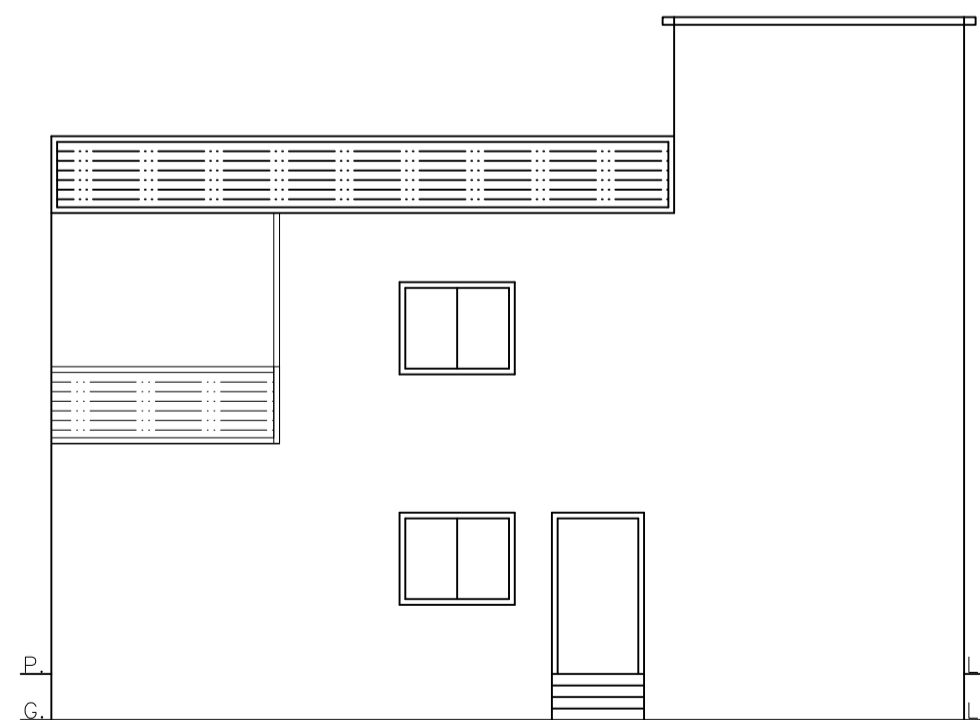

FRONT ELEVATION

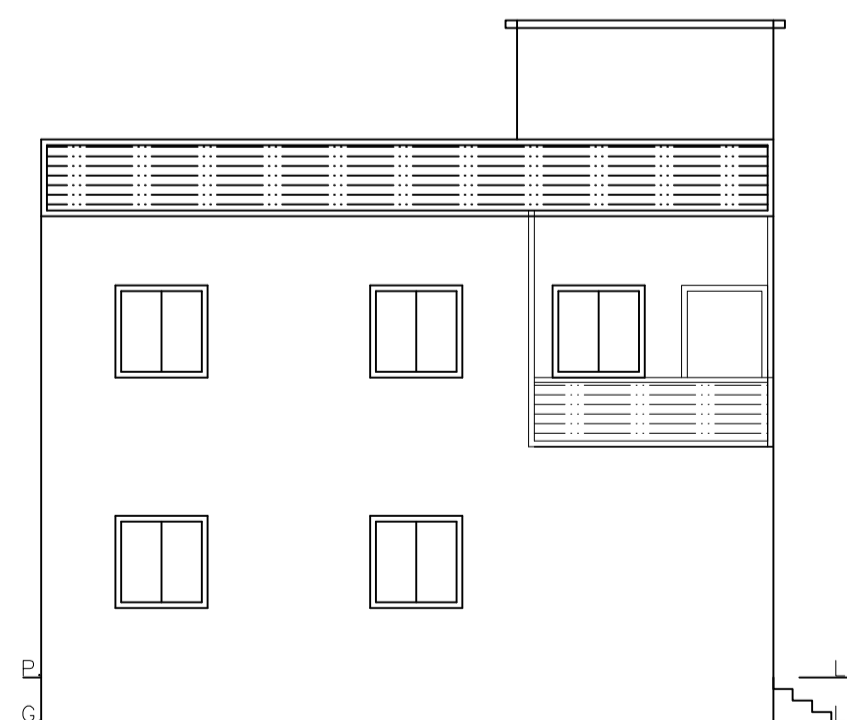

LEFT SIDE ELEVATION

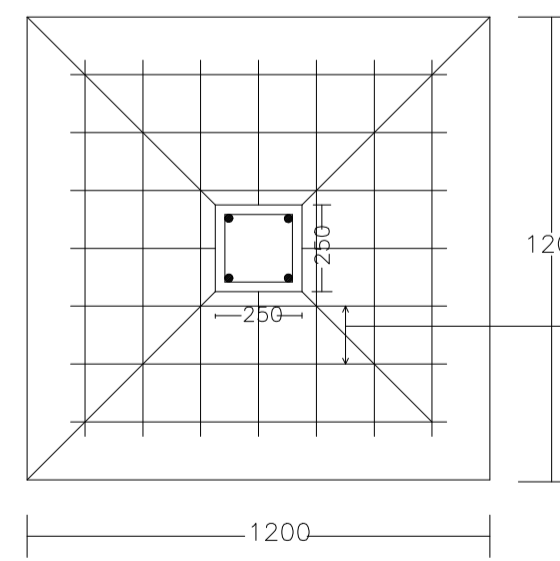

PLAN

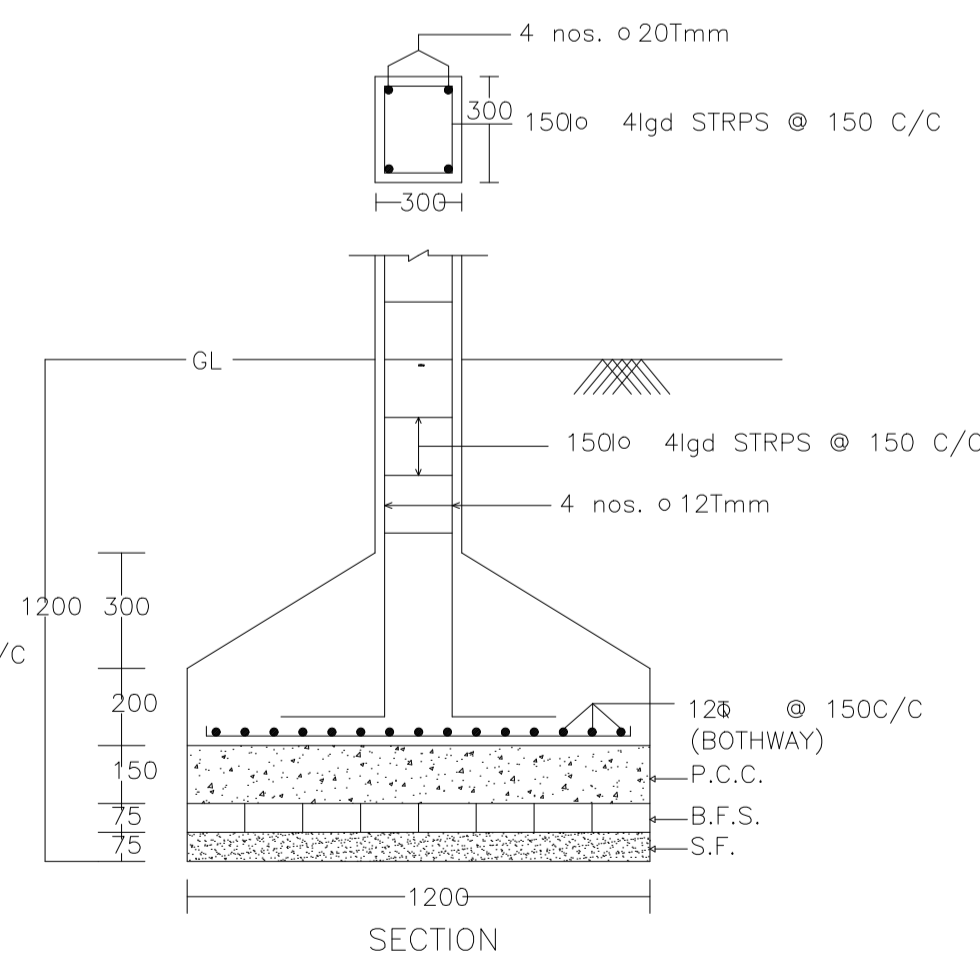

SECTION

DETAIL OF COLUMNS

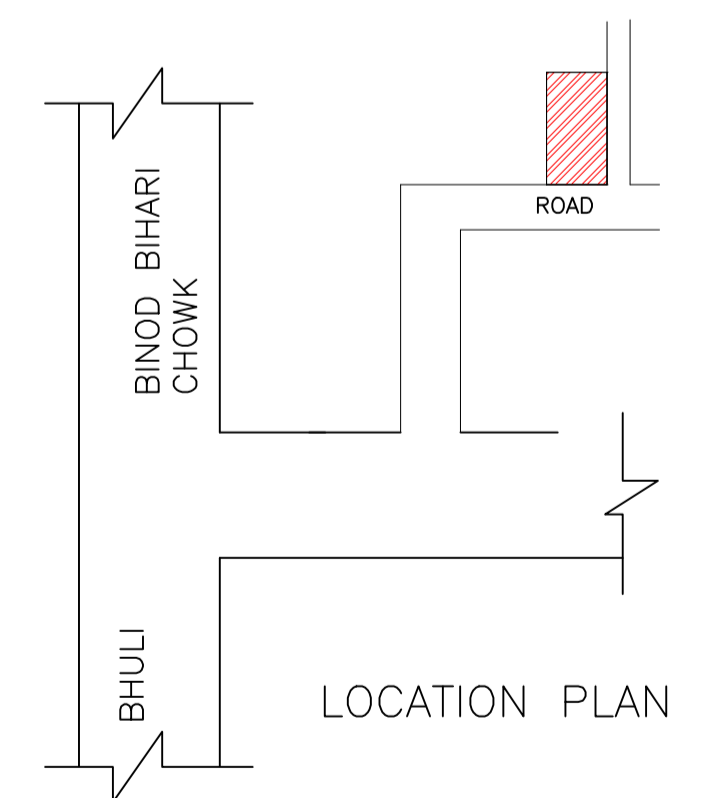

LOCATION PLAN

LTP NAME AND SIGNATURE	STRUCTURAL ENG'S NAME AND SIGNATURE	BUILDER NAME AND SIGNATURE	DIGITAL SIGNATURE
ABHISHEK KUMAR MADA/DFTMN0014/2020			