

VERTICAL & HORIZONTAL- 12Ø @0.15 C/C

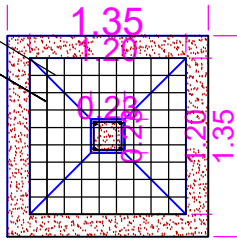

FOUNDATION PLAN

VERTICAL - 4 NOS. - 12Ø

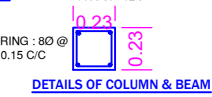

DETAILS OF COLUMN & BEAM

VERTICAL & HORIZONTAL- 12Ø @0.15 C/C

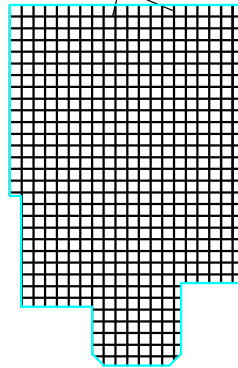

BOTTOM REINFORCEMENT PLAN

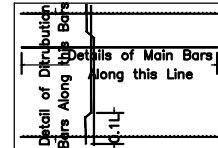

SECTION - D-D

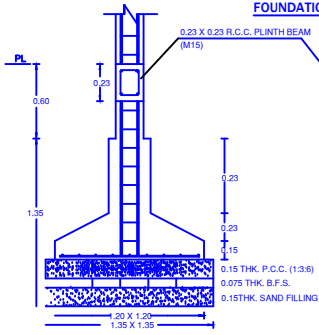

FOUNDATION DETAILS OF COLUMN

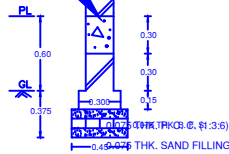

FOUNDATION DETAILS OF WALL

Structure Detail

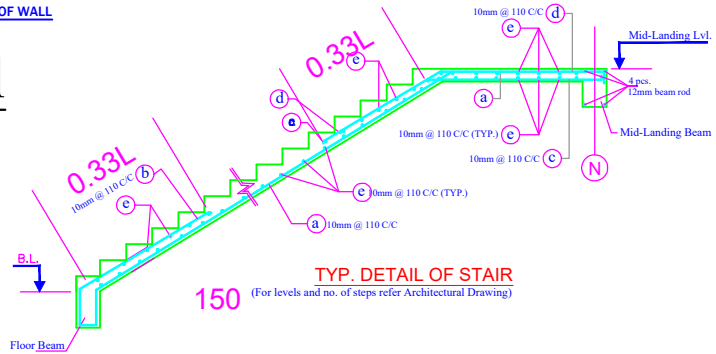

TYP. DETAIL OF STAIR
(For levels and no. of steps refer Architectural Drawing)