

Proposal Basic Information

Proposal File No.	MADA/BP/0360/2021
Owner Name	SMT. SARITA DEVI
Khata No	OLD-74, NEW-64
Plot No	OLD- 1454 NEW- 1633
Village Name	Nawadh
Use	Residential
SubUse	Bungalow/ Dwelling / Non Apartment

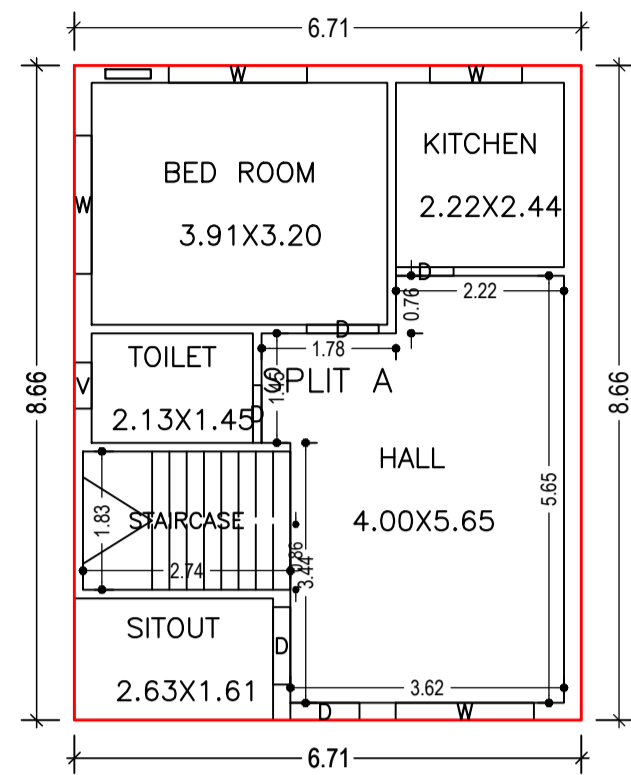

GROUND FLOOR PLAN (Proposed) (SCALE 1:100)

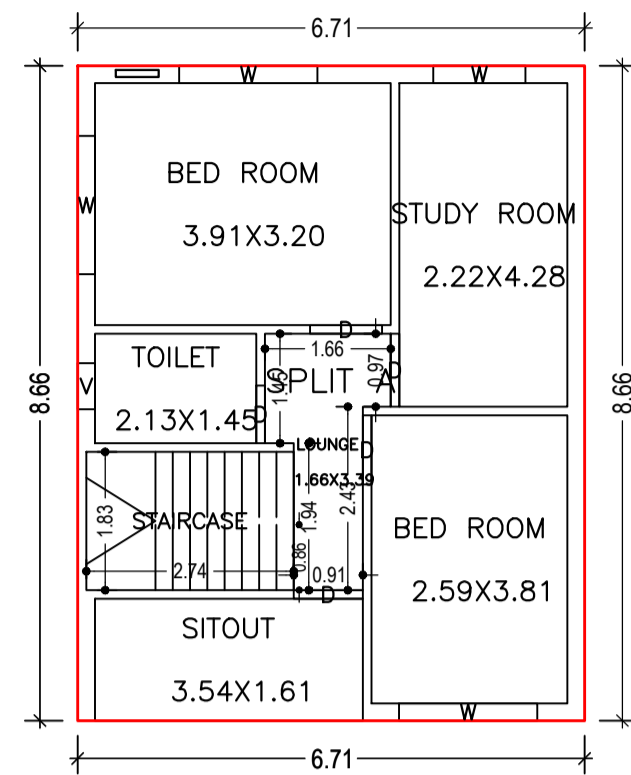

FIRST FLOOR PLAN (Proposed) (SCALE 1:100)

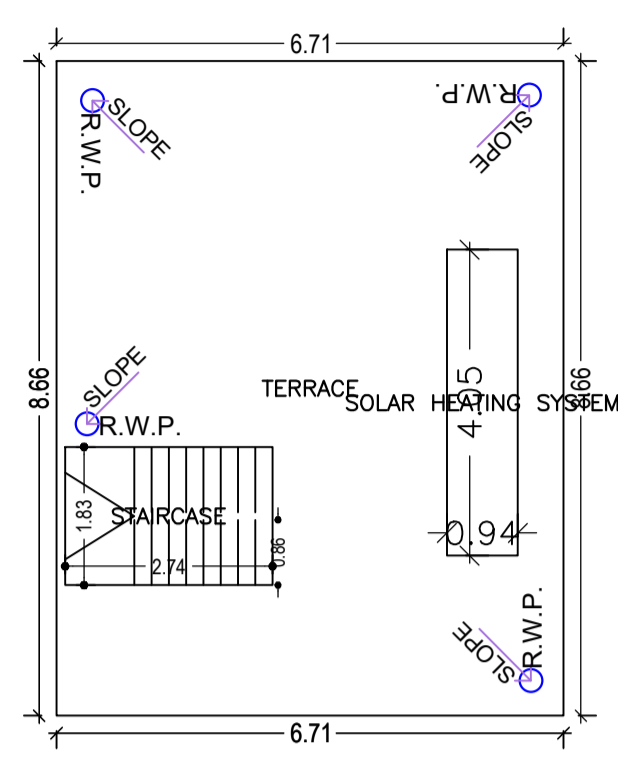

TERRACE FLOOR PLAN (SCALE 1:100)

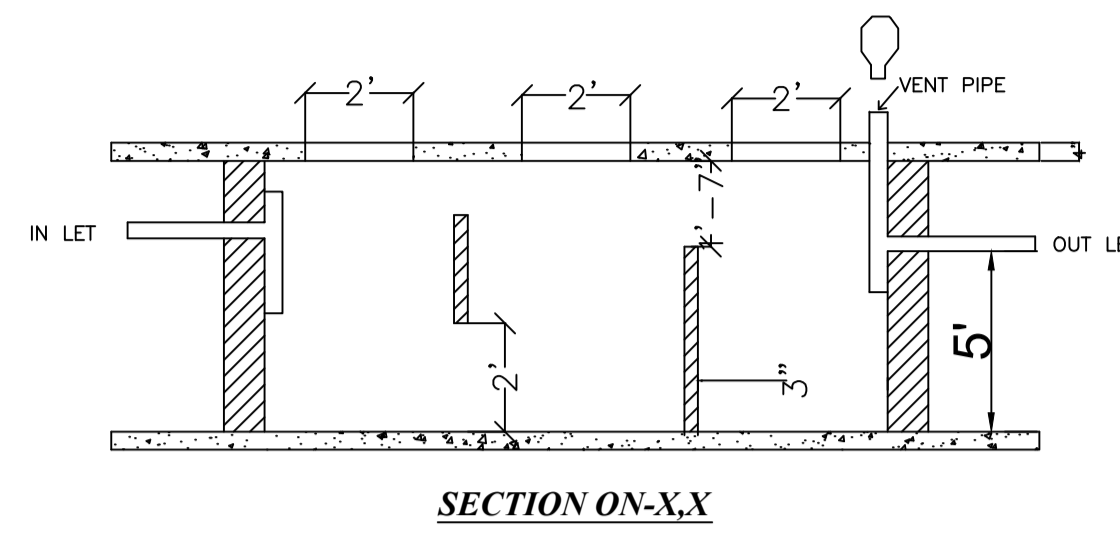

SECTION ON-X,X

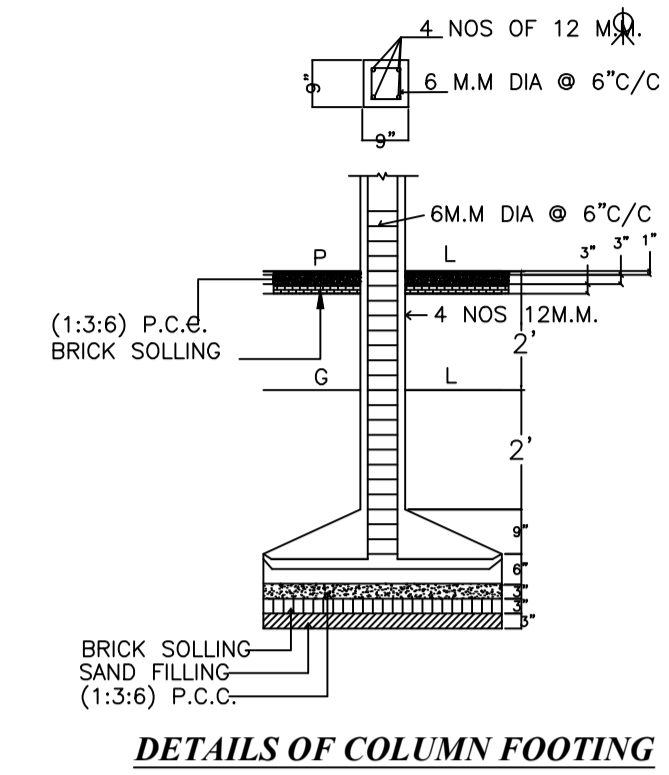

DETAILS OF COLUMN FOOTING

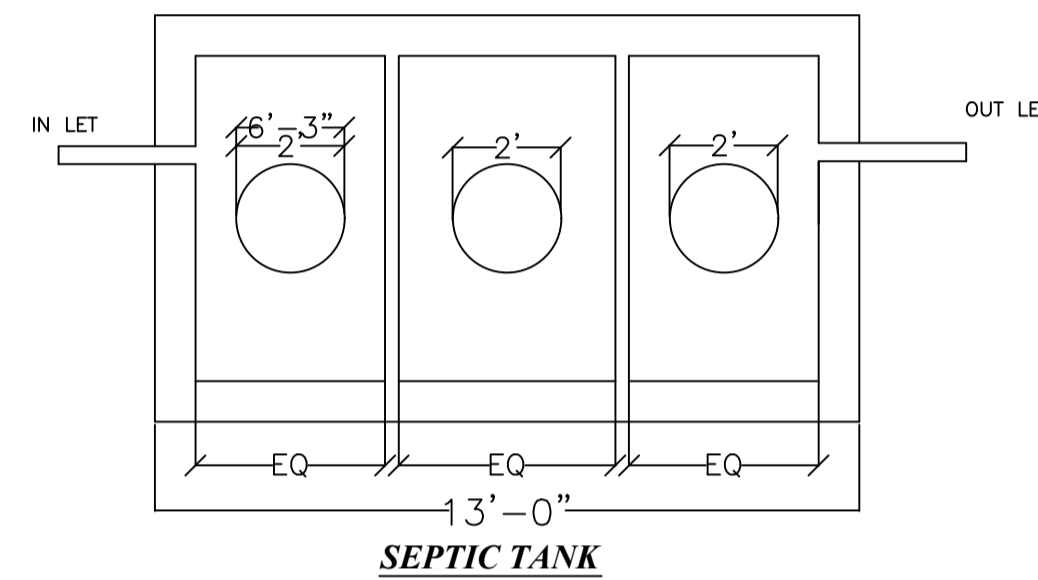

SEPTIC TANK

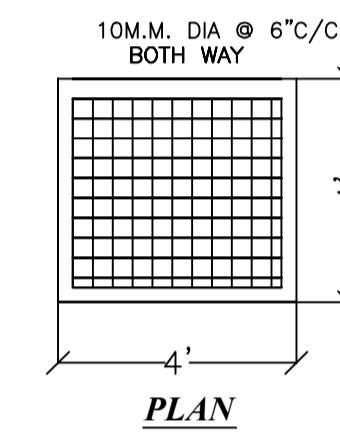

PLAN

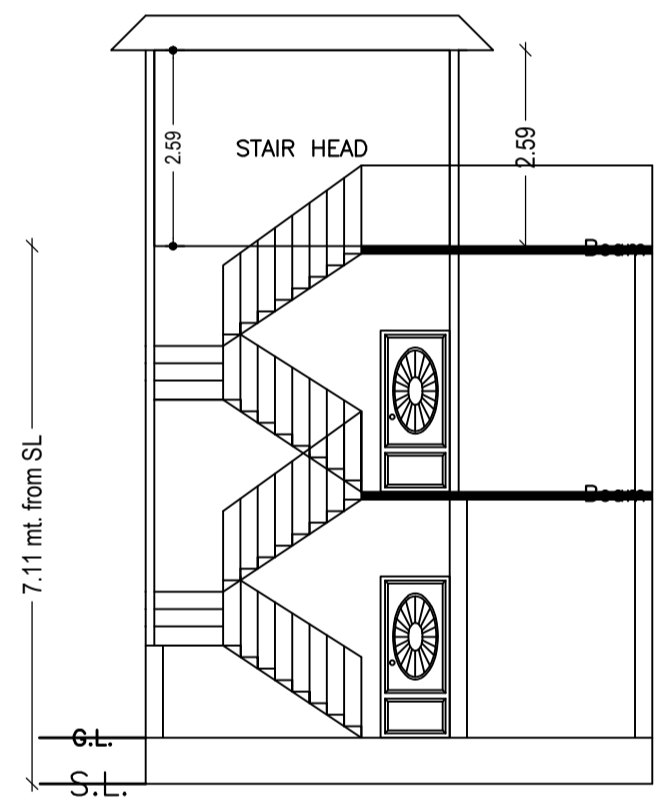

SECTION ON XX

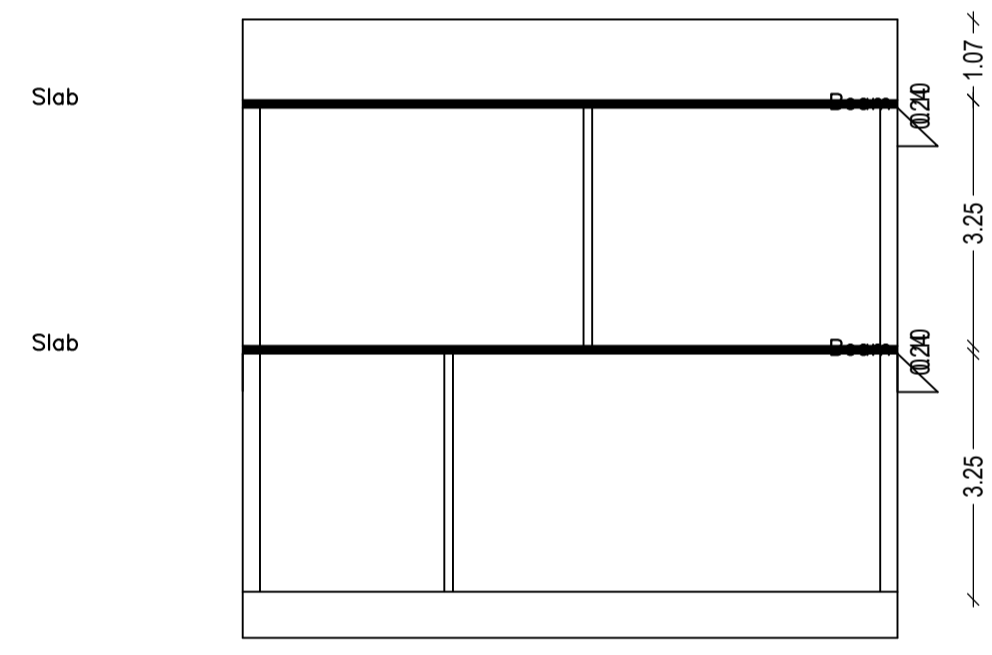

SECTION ON YY

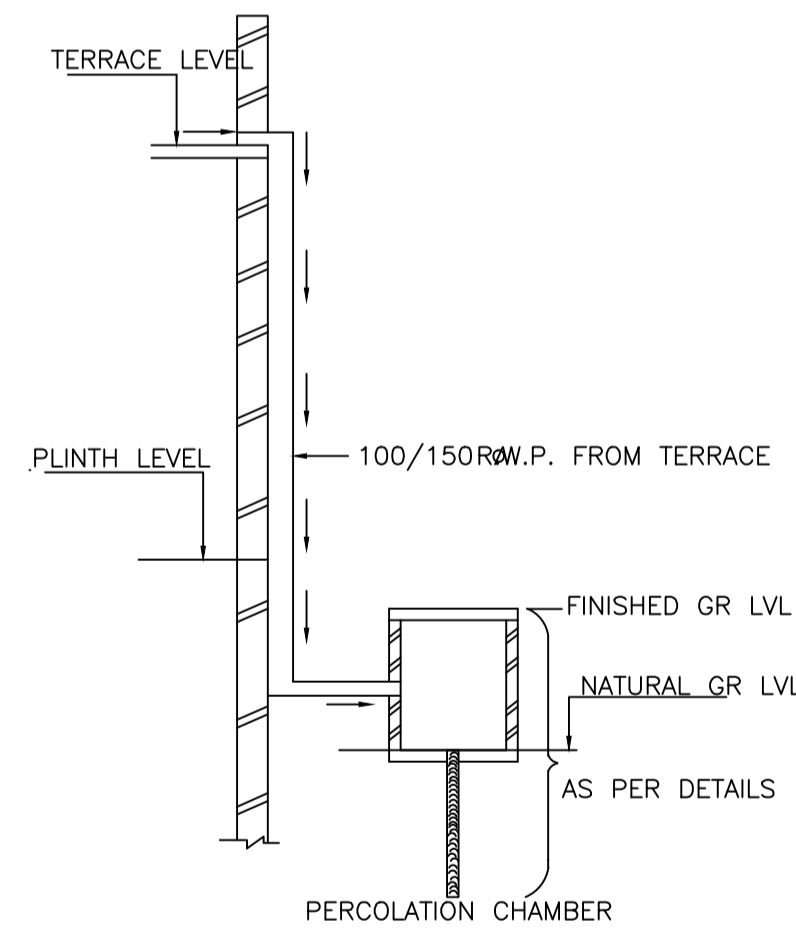

ROOF TOP RAIN WATER COLLECTION SYSTEM

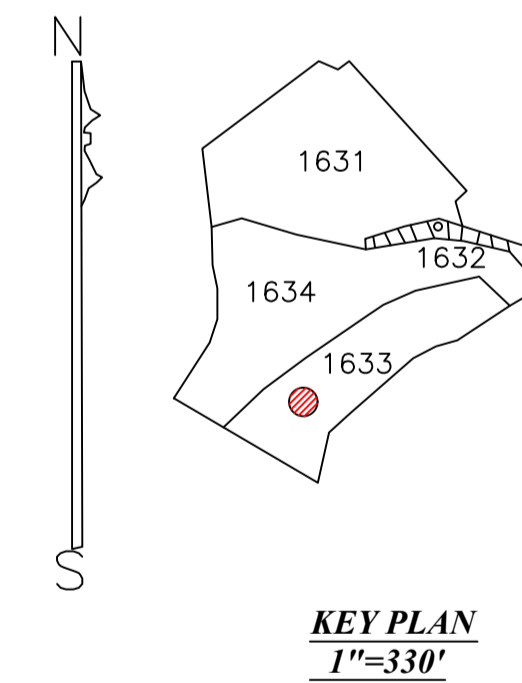

KEY PLAN 1"=330'

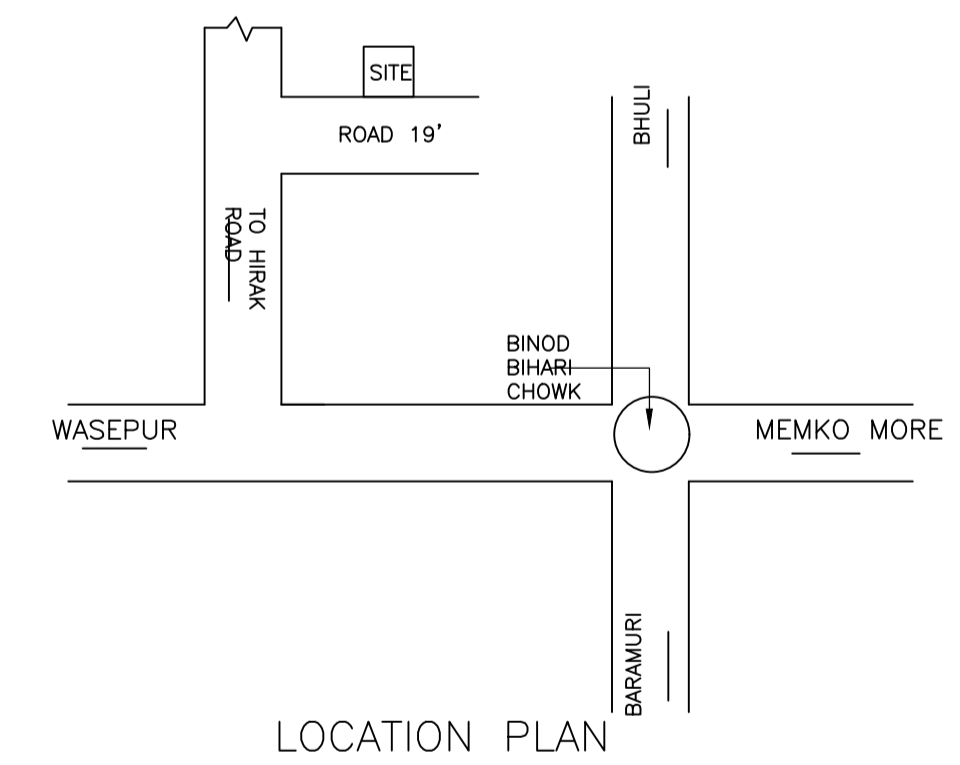

LOCATION PLAN

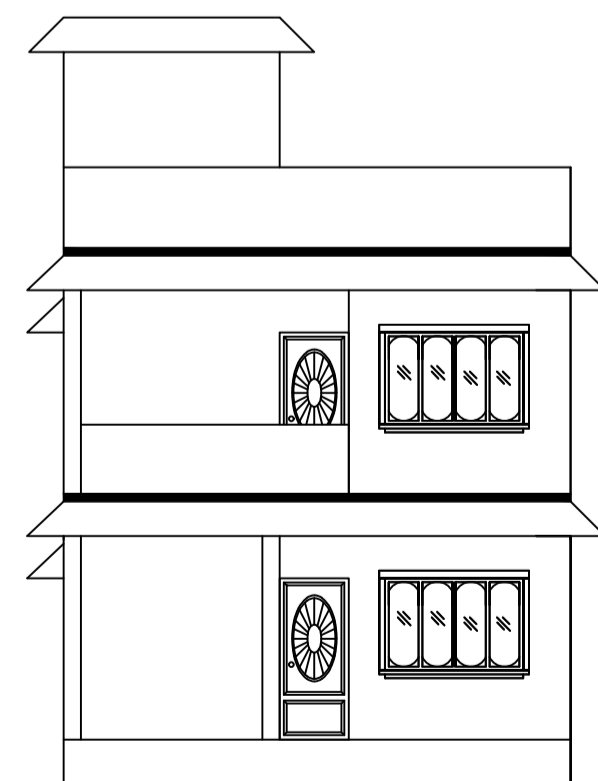

FRONT ELEVATION

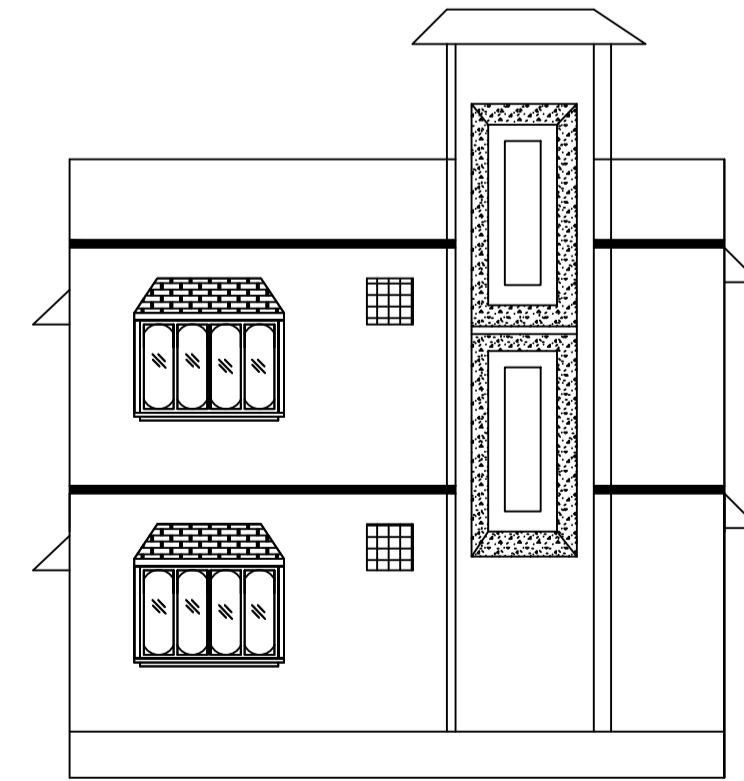

LEFT SIDE ELEVATION

LTP NAME AND SIGNATURE	STRUCTURAL ENG'S NAME AND SIGNATURE	BUILDER NAME AND SIGNATURE	DIGITAL SIGNATURE
SANTOSH MADA/ENG/0022/2019			