

SECTION ON X-X

SECTION ON Y-Y

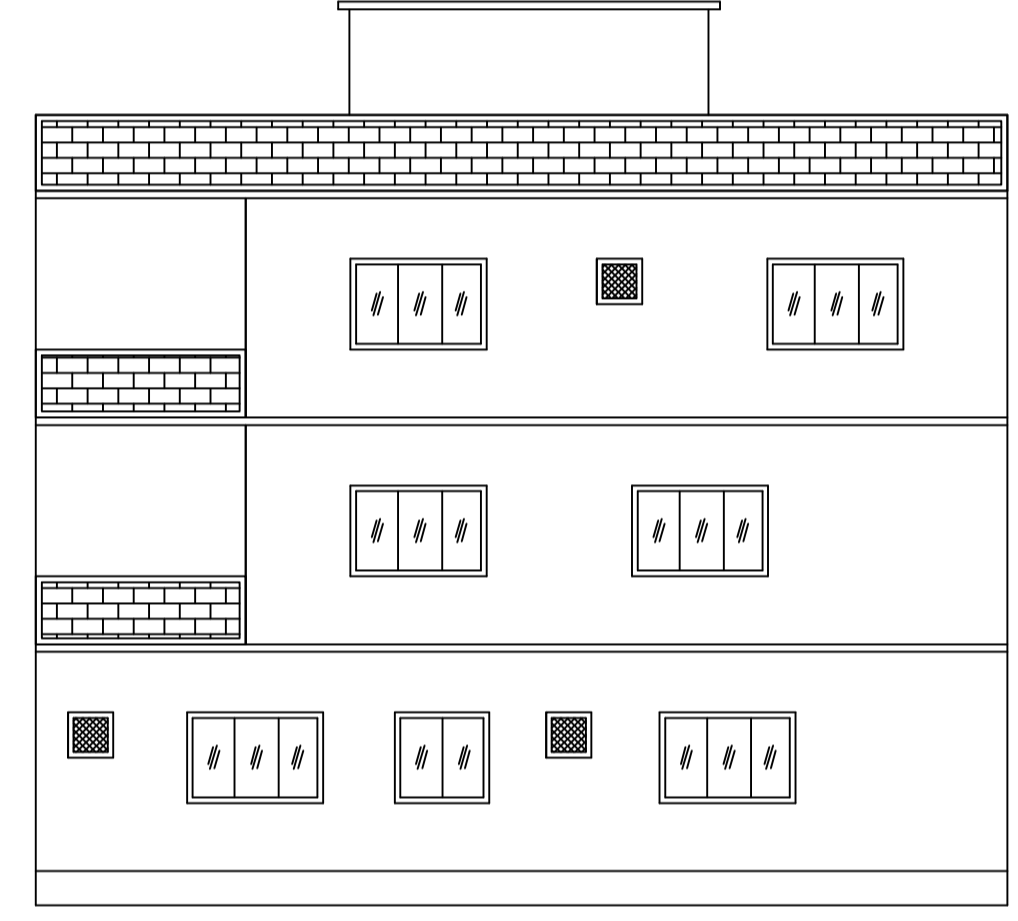
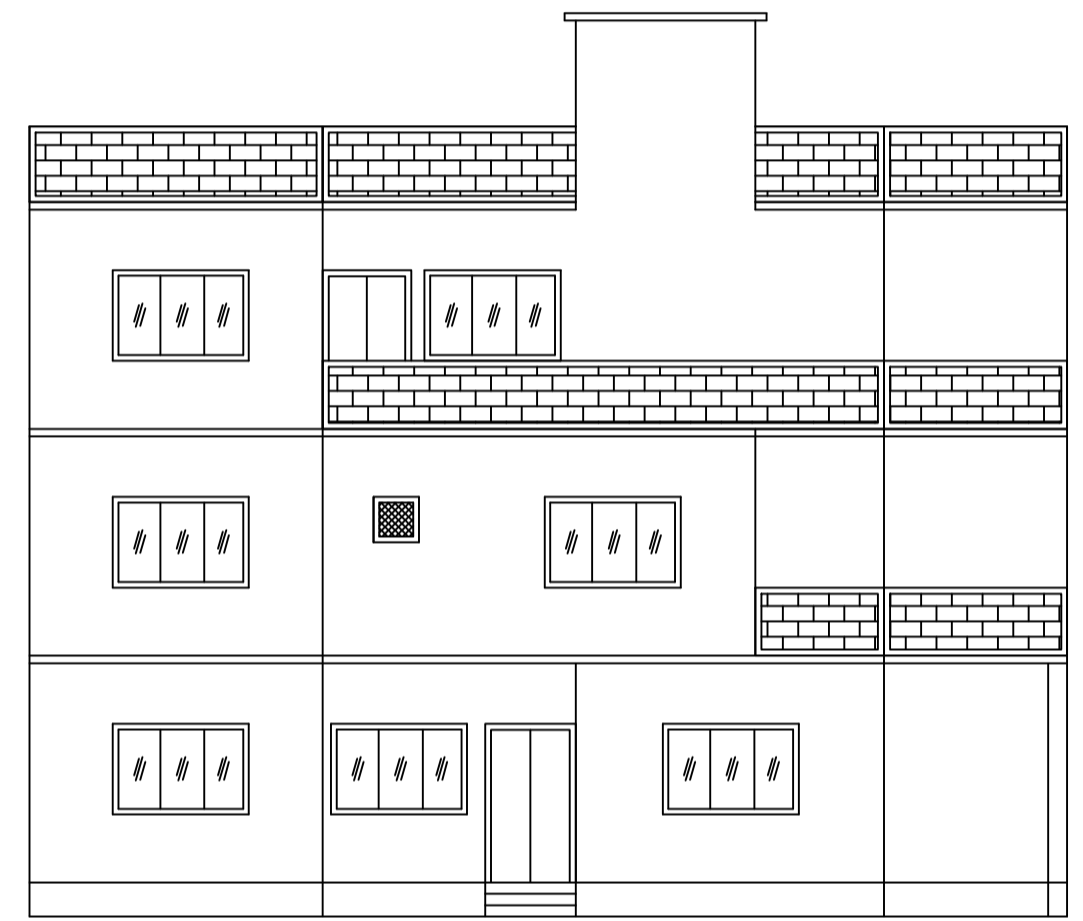

FRONT ELEVATION

LEFT SIDE ELEVATION

SCHEDULE OF DOOR:

BUILDING NAME	NAME	LENGTH	HEIGHT	NOS
AA (AA)	D3	0.78	2.10	07
AA (AA)	D2	0.78	2.10	01
AA (AA)	D3	0.90	2.10	03
AA (AA)	D	0.90	2.10	01
AA (AA)	D2	1.00	2.10	01
AA (AA)	D1	1.04	2.10	01
AA (AA)	D2	1.05	2.10	06
AA (AA)	D1	1.05	2.10	09
AA (AA)	D	1.05	2.10	05
AA (AA)	D3	1.06	2.10	01
AA (AA)	D	1.20	2.10	01

SCHEDULE OF WINDOW/VENTILATION:

BUILDING NAME	NAME	LENGTH	HEIGHT	NOS
AA (AA)	V	0.60	1.20	11
AA (AA)	W	0.90	1.20	03
AA (AA)	W1	1.20	1.20	01
AA (AA)	W1	1.25	1.20	01
AA (AA)	W1	1.43	1.20	01
AA (AA)	W	1.80	1.20	15
AA (AA)	W	2.88	1.20	01
AA (AA)	W	3.00	1.20	01

FAR & Tenement Details (Table 4c-1)

Building	No. of Same Bldg	Total Built Up Area (Sq.mt.)	Proposed FAR Area (Sq.mt.)	Total FAR Area (Sq.mt.)	Total Consumed Additional FAR Area (Sq.mt.)	Tnmt (No.)
AA (AA)	1	383.53	383.53	383.53	383.53	01
Grand Total :	1	383.53	383.53	383.53	383.53	01

UnitBUA Table for Building :AA (AA)

FLOOR	Name	UnitBUA Type	UnitBUA Area	Carpet Area	No. of Rooms	No. of Tenement
GROUND FLOOR PLAN	SPLIT AA	FLAT	383.54	383.28	11	1
FIRST FLOOR PLAN	SPLIT AA	FLAT	0.00	0.00	14	0
SECOND FLOOR PLAN	SPLIT AA	FLAT	0.00	0.00	9	0
Total:	-	-	383.54	383.28	34	1

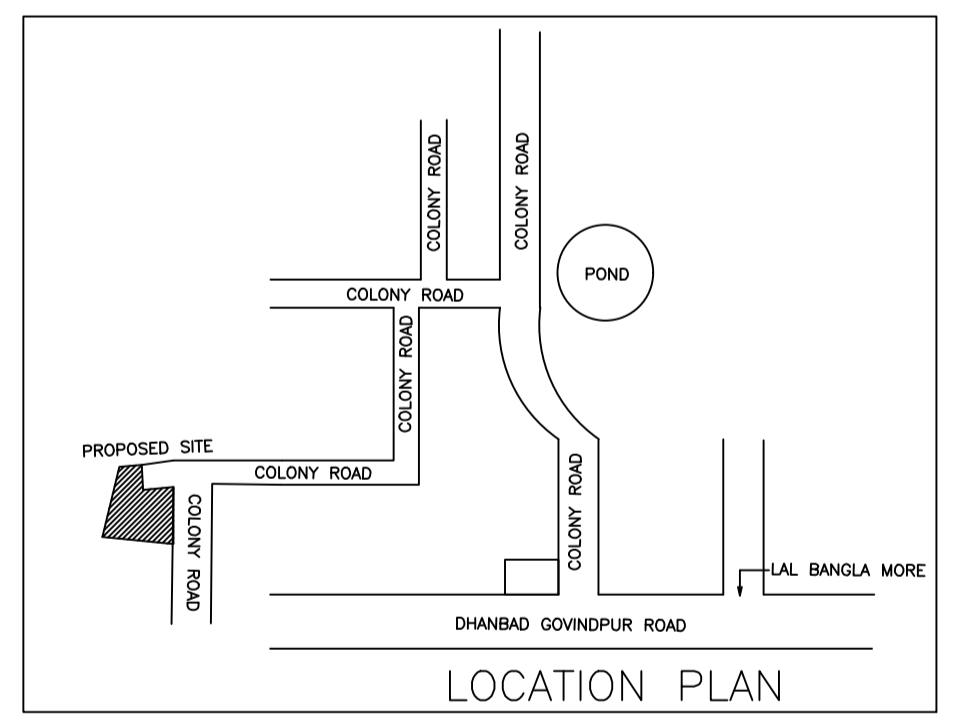

LOCATION PLAN

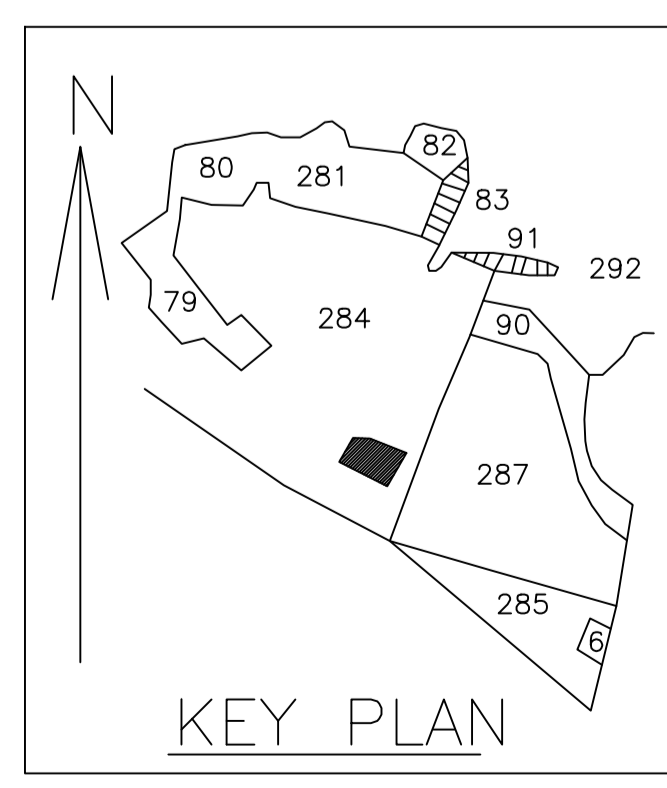

KEY PLAN

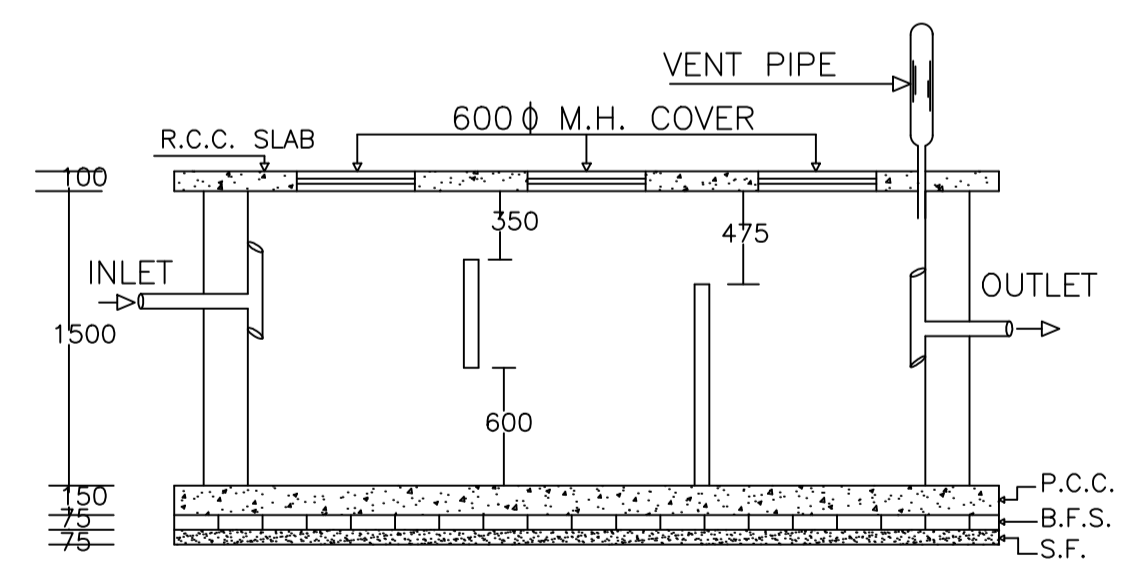

PLAN OF SEPTIC TANK

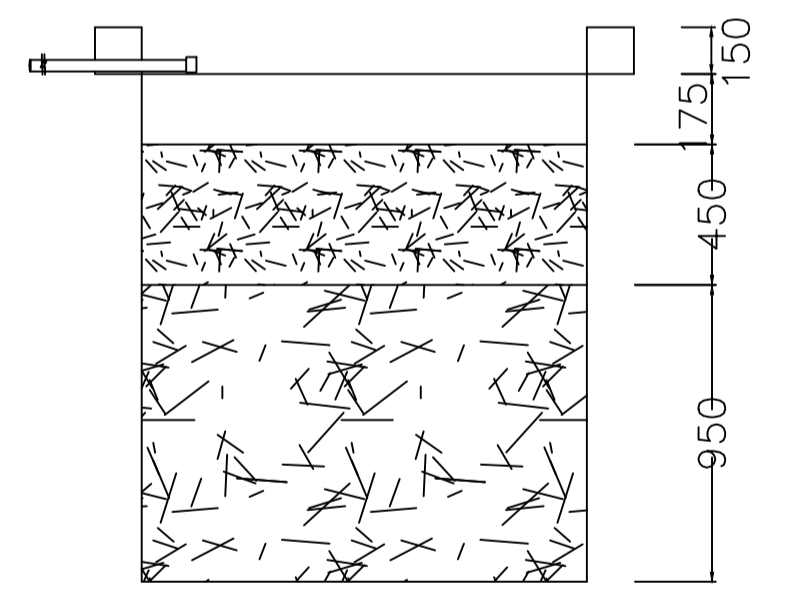

PLAN OF RECHARGE WELL WATER HARVESTING

Proposal Basic Information

Proposal File No.	MADA/BP/0176/2022
Owner Name	SRI CHANDRA SHEKHAR PRASAD
Khata No	17(OLD), 53(NEW)
Plot No	284(old) 348(new)
Village Name	Kangalo
Use	Residential
SubUse	Bungalow/ Dwelling / Non Apartment

AREA STATEMENT MINERAL AREA DEVELOPMENT AUTHORITY		VERSION NO.: 1.0.62	VERSION DATE: 16/10/2020
PROJECT DETAIL:			
Region: JHARKHAND URBAN LOCAL BODIES	Plot Use: Residential		
District: DHANBAD	Plot SubUse: Bungalow/ Dwelling / Non Apartment		
Authority: MINERAL AREA DEVELOPMENT AUTHORITY	Plot/Nearby/Religious Structure: NA		
Inward No: MADA/BP/0176/2022	Plot/SubPlot No: 284(old) 348(new)		
Application Type: General Proposal	North: Plot No. - 0.60 WIDE DRAIN		
Project Type: Building Permission	South: CTS No. - USHA DEVI		
Nature of Development: New	East: Road Width - 4.26 WIDE ROAD		
Location of Development Area: Old Area	West: Plot No. - PART OF PLOT NO. 284		
AREA DETAILS:			
AREA OF PLOT (Minimum)	(A)		SQ.MT. 299.43
NET AREA OF PLOT (Gross Plot Area - Deduction from Gross Plot area)	(A-Deductions)		299.43
Deduction for Balance Plot Area (from Gross Plot Area)			
Common Plot			46.14
Total			46.14
BALANCE AREA OF PLOT (Net Plot Area - Recreational/Amenity space)	(A-Deductions)		213.29
PLOT AREA FOR COVERAGE (Net Plot Area)	(A-Deductions)		299.43
Plot Area for FAR (Net Plot Area + Road Widening Area)	(A-Deductions)		299.43
COVERAGE CHECK			
Permissible Coverage area (60.00 %)			155.66
Proposed Coverage Area (52.08 %)			135.10
Total Prop. Coverage Area (52.08 %)			135.10
Balance coverage area (7.93 %)			20.56
FAR CHECK			
Perm. FAR Area (1.50)			389.14
Total Perm. FAR area			389.14
Residential FAR			383.54
Proposed FAR Area			383.54
Total Proposed FAR Area			383.54
Consumed FAR (Factor)			1.48
Balance FAR Area			5.60
BUILT UP AREA CHECK			
Total Proposed Built Up Area			383.53
ARCHITECT (Regd)		RAJEEV RANJAN SINGH	
ENGINEER (Regd)			
SUPERVISOR (Regd)			
OWNER (Regd)		SRI CHANDRA SHEKHAR PRASAD	
DEVELOPMENT AUTHORITY		LOCAL BODY	

COLOR INDEX

PLOT BOUNDARY	Black
ABUTTING ROAD	Green
PROPOSED CONSTRUCTION	Red
COMMON PLOT	Yellow
ROAD WIDENING AREA	Orange
EXISTING (To be retained)	Blue
EXISTING (To be demolished)	Light Blue

Buildingwise Floor FAR Details

Floor Name	Building Name AA (AA)		Total	
	Proposed Built Up Area (Sq.mt.)	Proposed FAR Area (Sq.mt.)	Total Proposed Built Up Area (Sq.mt.)	Total FAR Area (Sq.mt.)
Ground Floor	135.10	135.10	135.10	135.10
First Floor	135.10	135.10	135.10	135.10
Second Floor	113.33	113.33	113.33	113.33
Terrace Floor	0.00	0.00	0.00	0.00
Total :	383.53	383.53	383.53	383.53

Building USE/SUBUSE Details

Building Name	Building Use	Building SubUse	Building Structure
AA (AA)	Residential	Bungalow/ Dwelling / Non Apartment	Non-Highrise

Building :AA (AA)

Floor Name	Total Built Up Area (Sq.mt.)	Proposed FAR Area (Sq.mt.)		Total Consumed Additional FAR Area (Sq.mt.)	Tnmt (No.)
		Resi.	Additional FAR		
Ground Floor	135.10	135.10	135.10	135.10	01
First Floor	135.10	135.10	135.10	135.10	00
Second Floor	113.33	113.33	113.33	113.33	00
Terrace Floor	0.00	0.00	0.00	0.00	00
Total :	383.53	383.53	383.53	383.53	01
Total Number of Same Buildings	1				
Total :	383.53	383.53	383.53	383.53	01

LTP NAME AND SIGNATURE	STRUCTURAL ENG'S NAME AND SIGNATURE	BUILDER NAME AND SIGNATURE	DIGITAL SIGNATURE
RAJEEV RANJAN SINGH MADA/ENG/0004/2019			

Proposal Basic Information

Proposal File No.	MADA/BP/0176/2022
Owner Name	SRI CHANDRA SHEKHAR PRASAD
Khata No	17(OLD), 53(NEW)
Plot No	284(old) 348(new)
Village Name	Kangalo
Use	Residential
SubUse	Bungalow/ Dwelling / Non Apartment

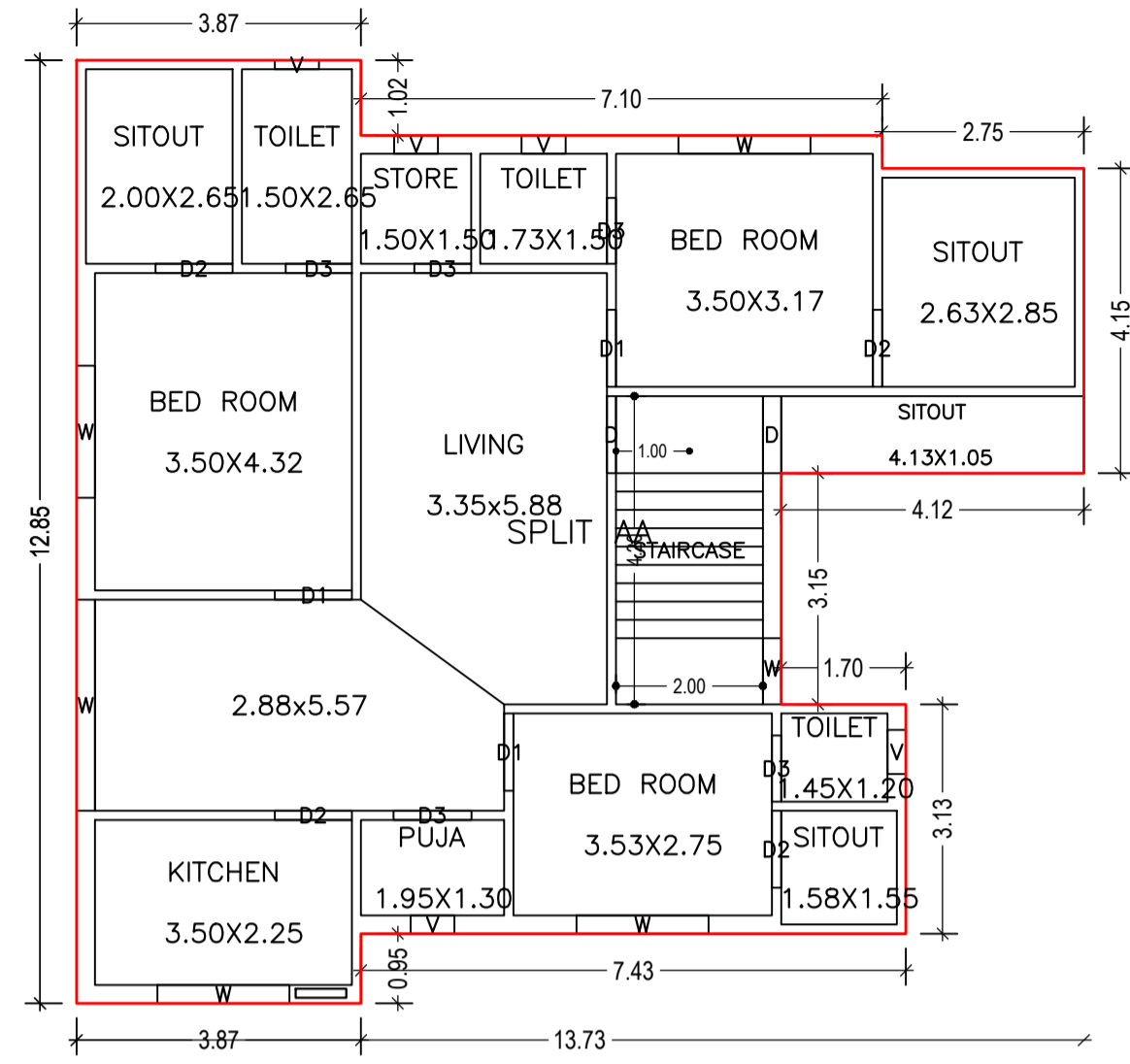

FIRST FLOOR PLAN
(Proposed)
(SCALE 1:100)

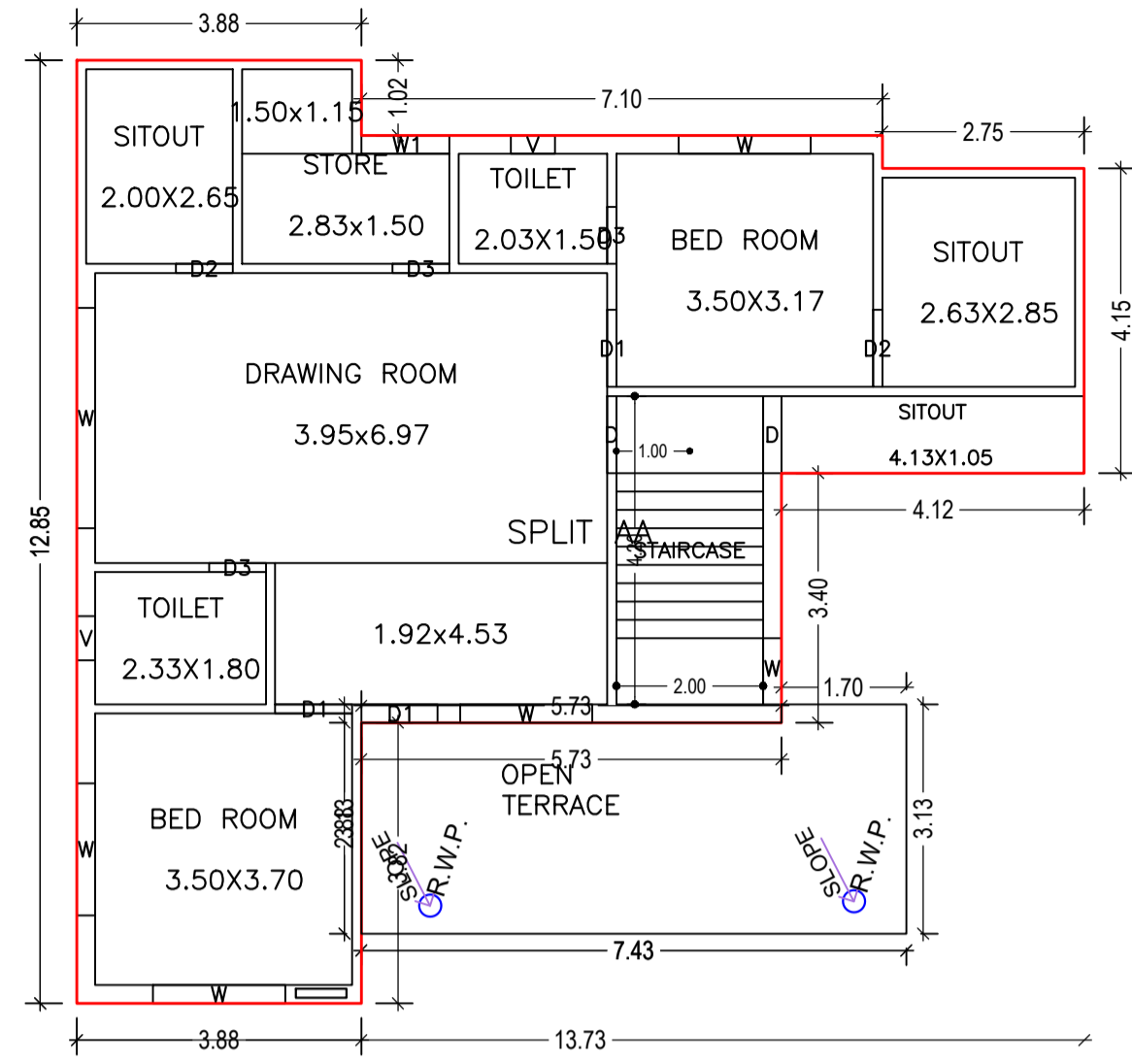

SECOND FLOOR PLAN
(Proposed)
(SCALE 1:100)

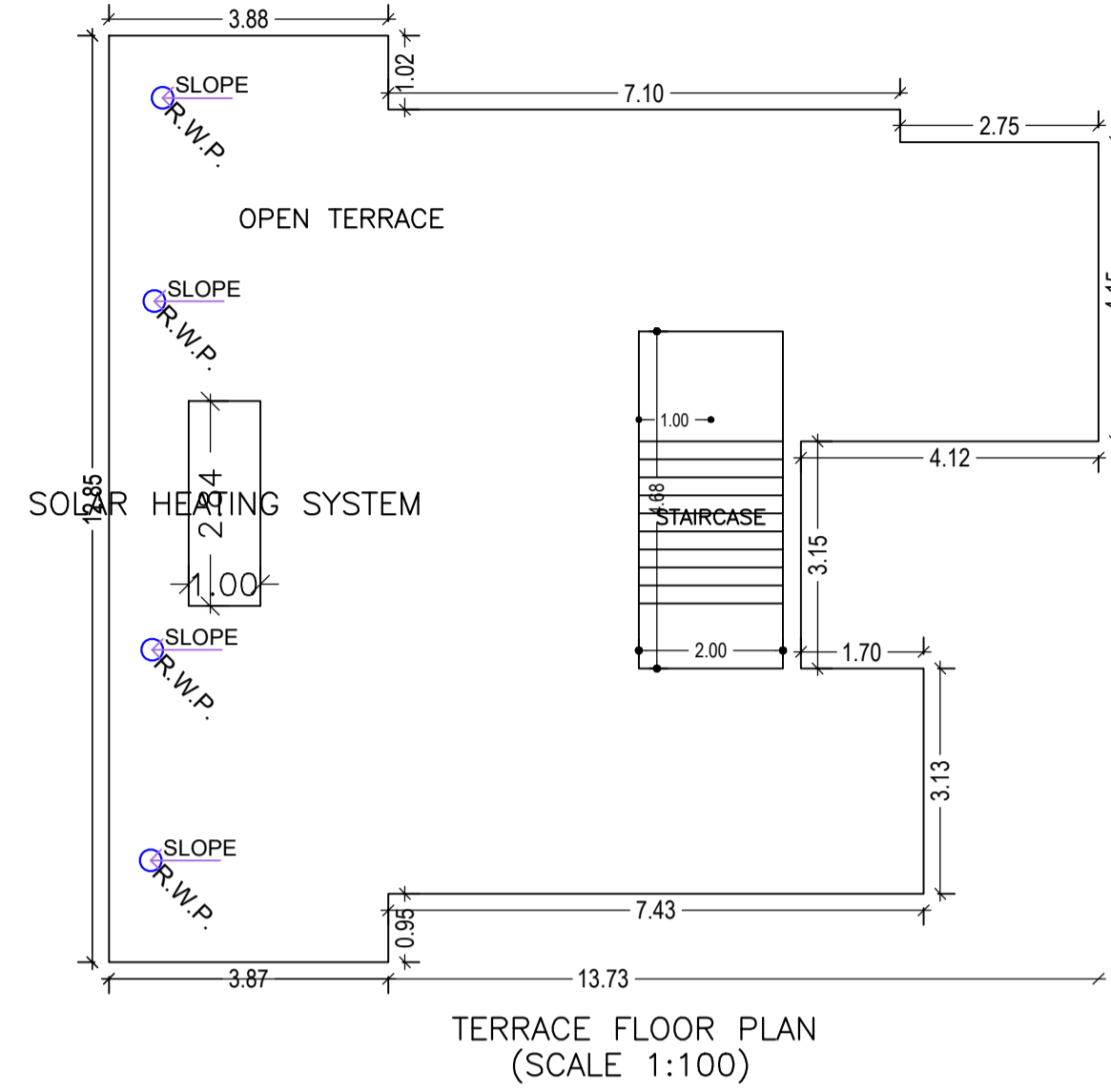

TERRACE FLOOR PLAN
(SCALE 1:100)

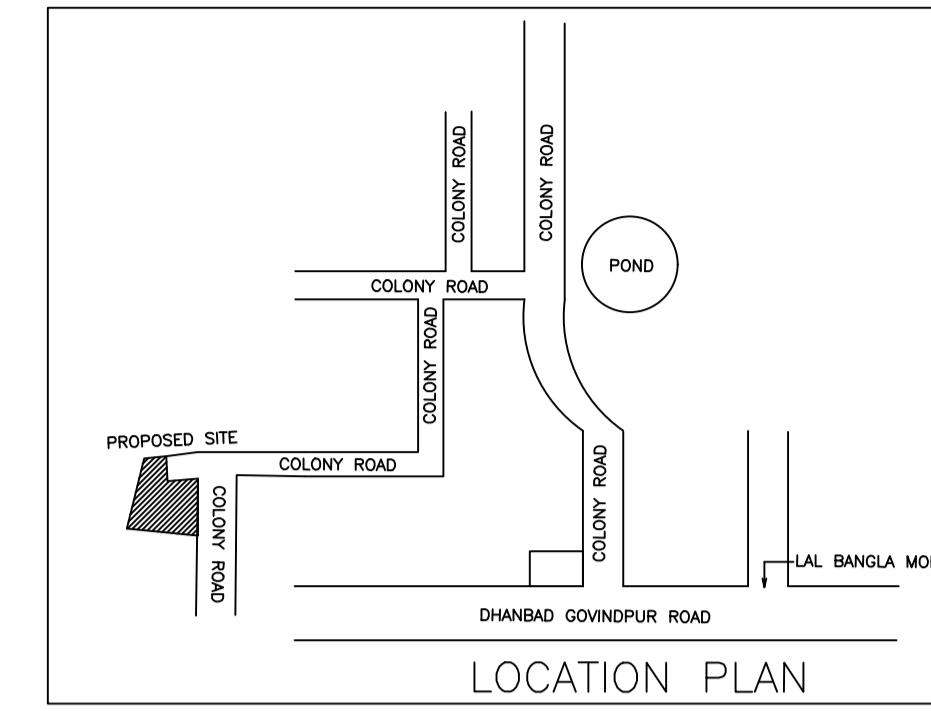

LOCATION PLAN

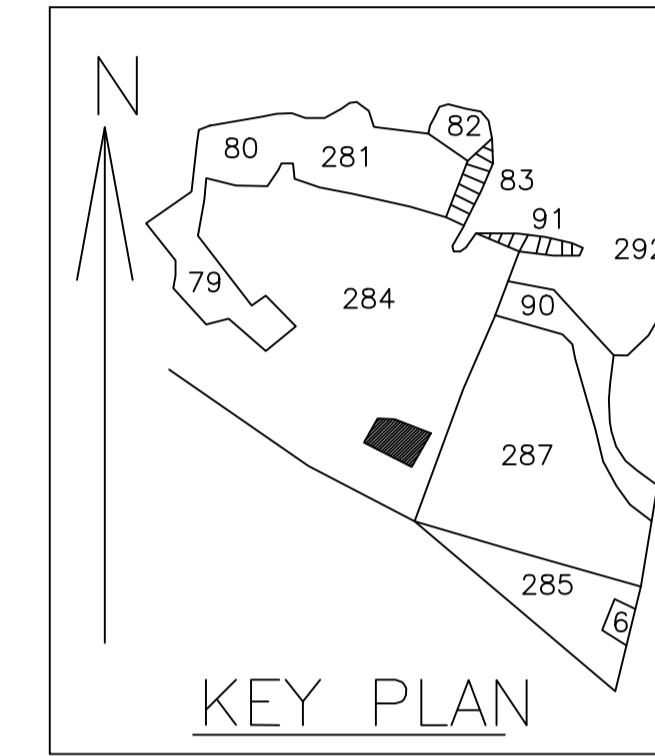

KEY PLAN

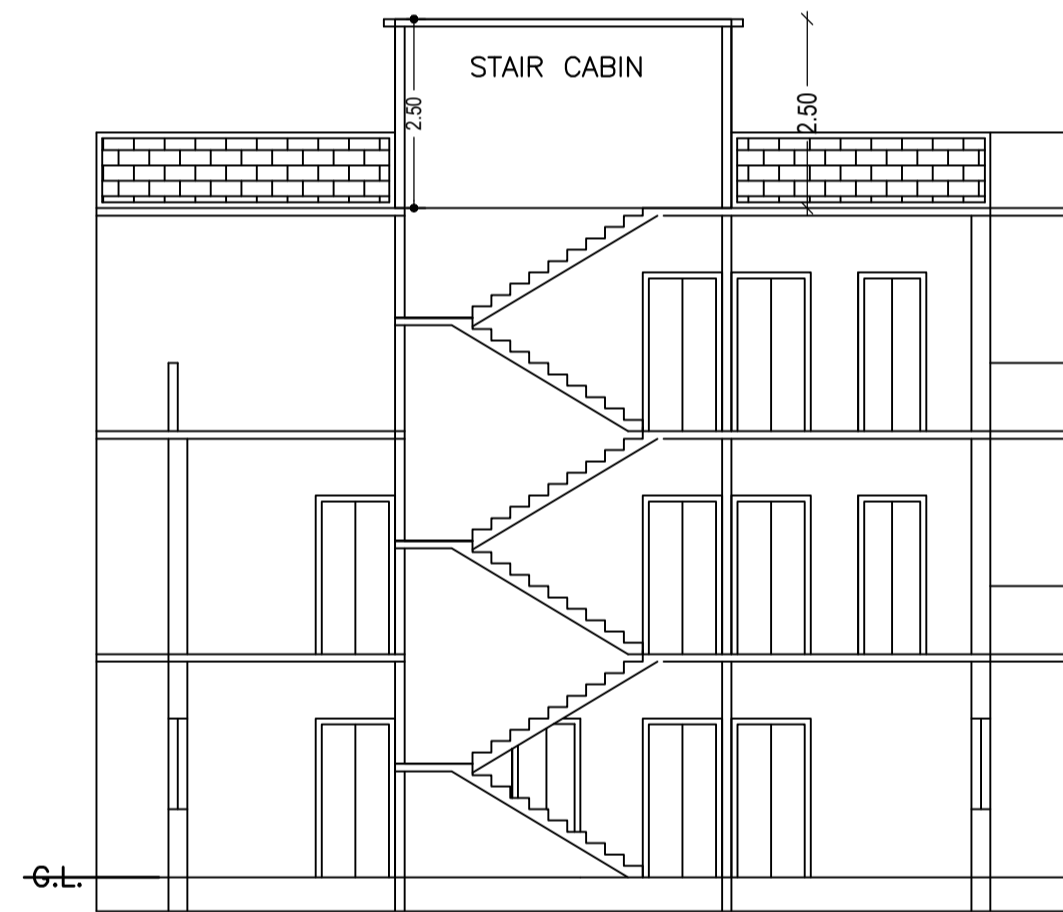

SECTION ON X-X

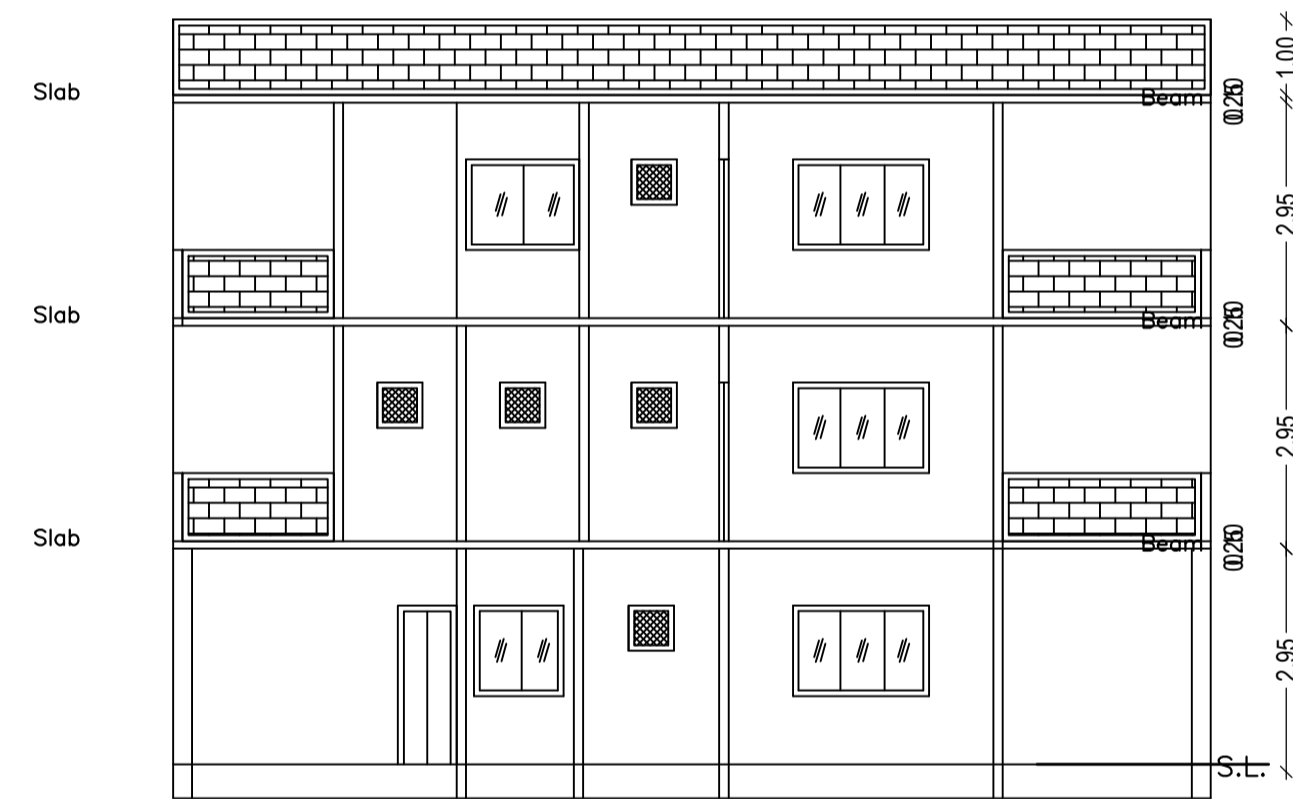

SECTION ON Y-Y

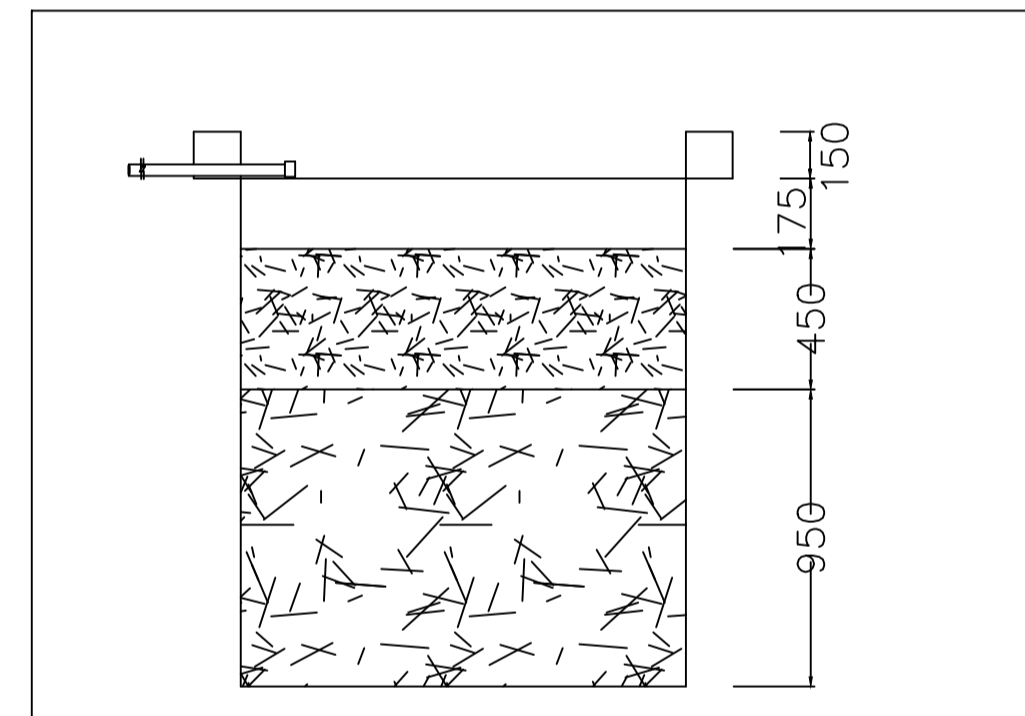

SECTION AT Y-Y

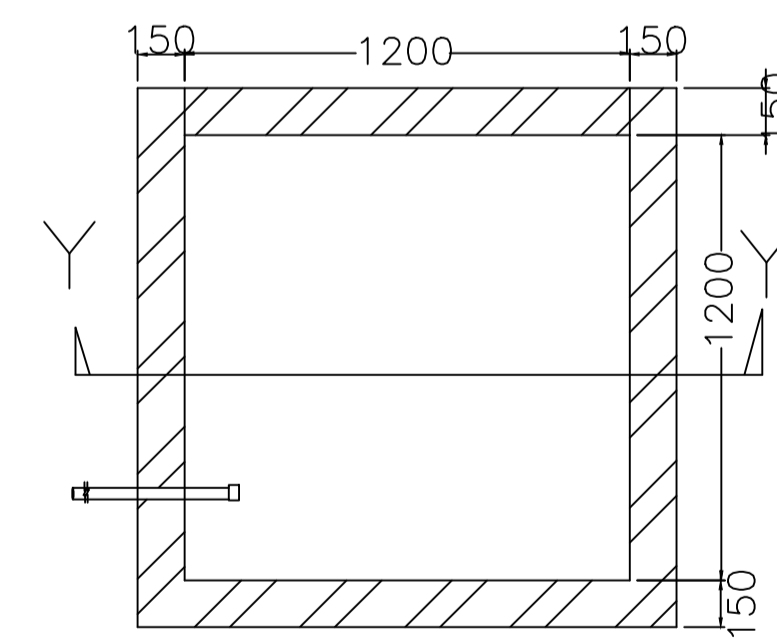

PLAN OF RECHARGE WELL

WATER HARVESTING

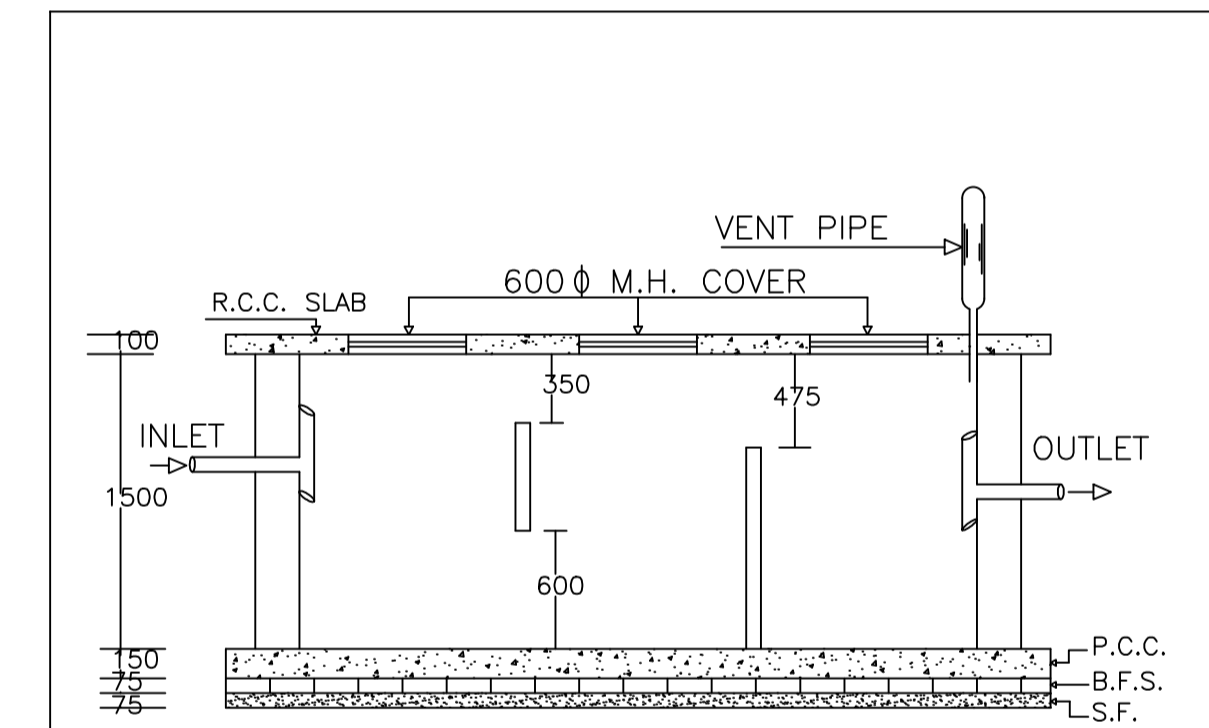

PLAN OF SEPTIC TANK

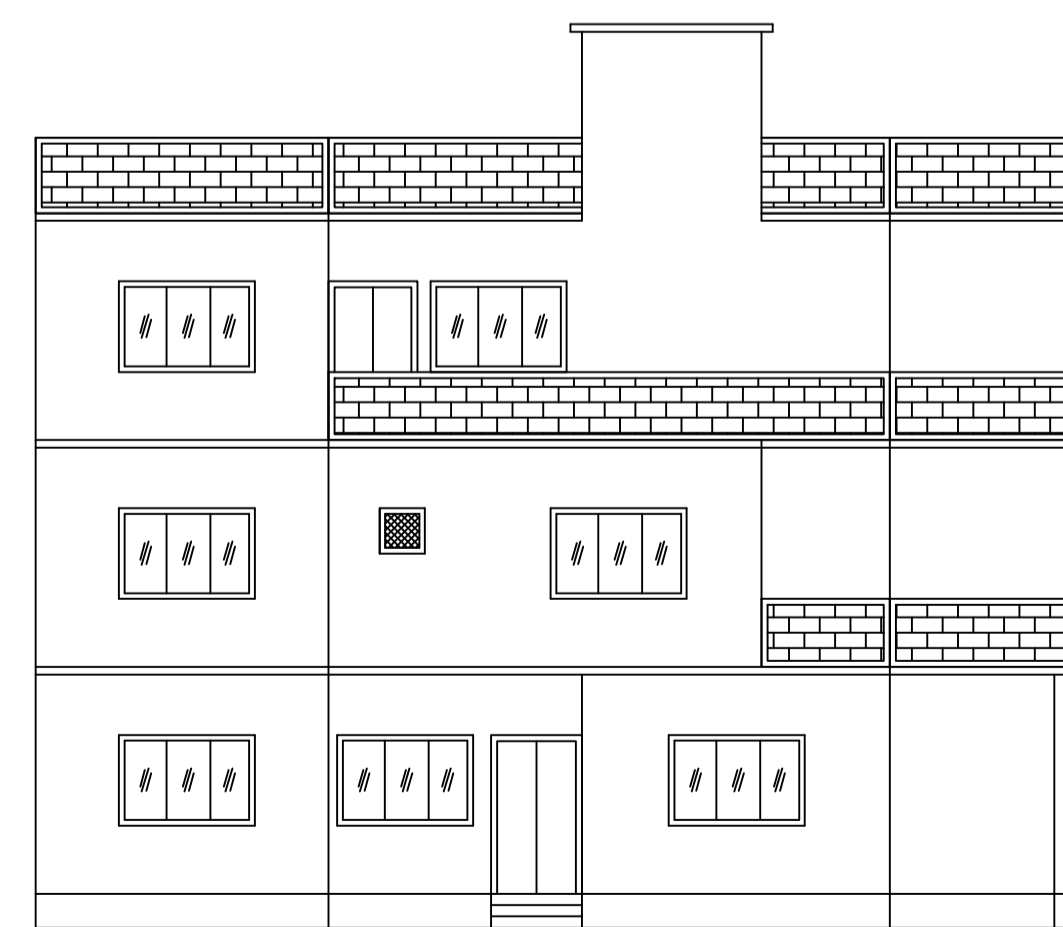

FRONT ELEVATION

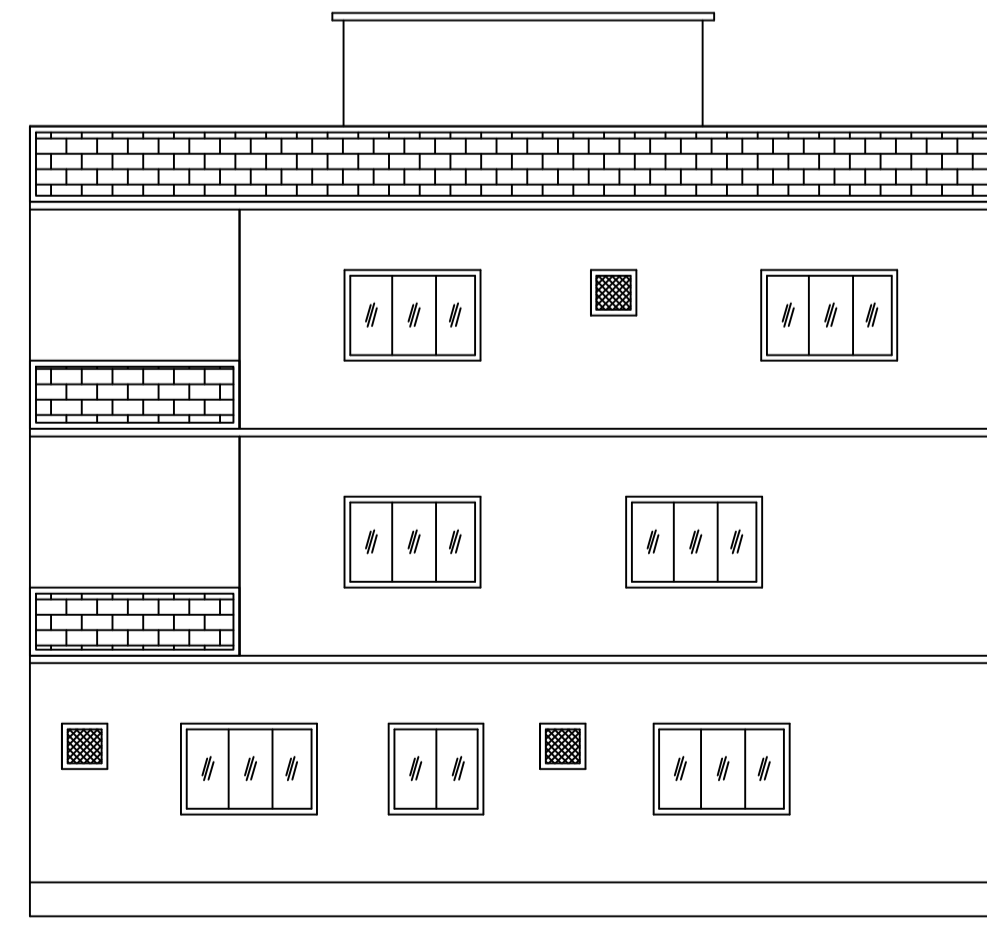

LEFT SIDE ELEVATION

LTP NAME AND SIGNATURE RAJEEV RANJAN SINGH MADA/ENG/0004/2019	STRUCTURAL ENG'S NAME AND SIGNATURE	BUILDER NAME AND SIGNATURE	DIGITAL SIGNATURE
---	-------------------------------------	----------------------------	-------------------